

SERVICE MANUAL

MODEL P9500

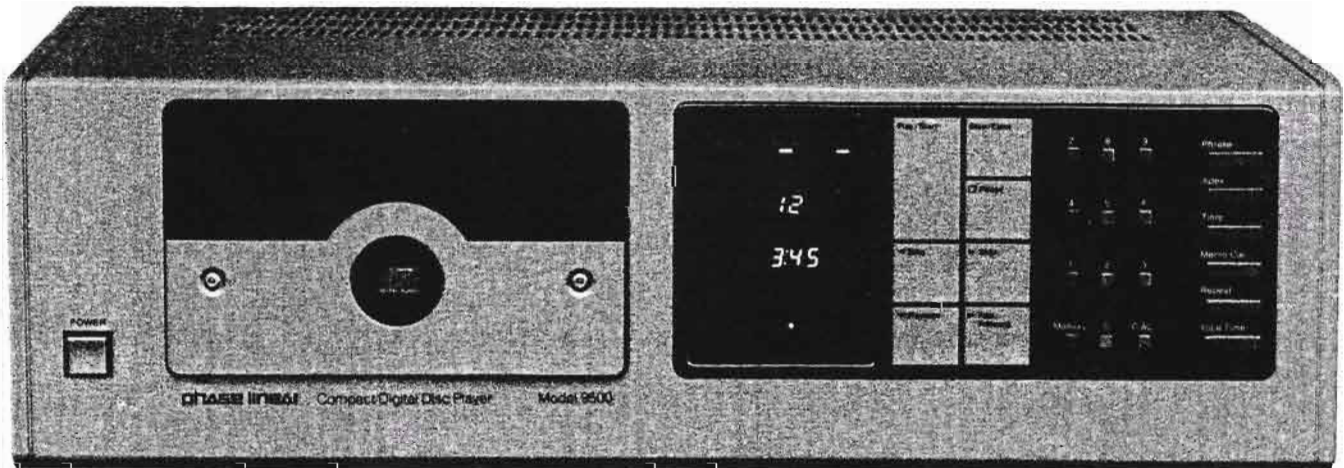

phase linear™

Phase Linear
4136 North United Parkway
Schiller Park, IL 60176



For parts and service information, call 1-800-323-0221 Toll Free
In Illinois, call 312-671-4760

Division of International Jensen Incorporated/an **ESMARK** Company

	Page
Specifications	3
Alignment procedure	4
Chassis layout	5
Functional block diagram	6
Test point scope check	7 ~ 9
Semiconductor basing information	10 ~ 11
Quick trouble shooting charts	12 ~ 14
PC board layout	15 ~ 18
Wiring diagram (1)	19
Wiring diagram (2)	20
Wiring diagram (3)	21
Schematic diagram (1)	22
Schematic diagram (2)	23
Schematic diagram (3)	24
Exploded view	25
Replacement Parts List	26 ~ 31

Recommended equipment

Tektronics power meter J16 digital photo meter
 Test disk Sony test CD Type No. 3 YEDS7

	CAUTION RISK OF ELECTRIC SHOCK DO NOT OPEN	
<p>CAUTION: TO REDUCE THE RISK OF ELECTRIC SHOCK, DO NOT REMOVE COVER (OR BACK). NO USER-SERVICEABLE PARTS INSIDE. REFER SERVICING TO QUALIFIED SERVICE PERSONNEL.</p>		



This symbol is intended to alert you of the presence of uninsulated dangerous voltage within the unit's enclosure that may be of sufficient magnitude to constitute a risk of electric shock.



This symbol is intended to alert you of the presence of important operating and maintenance instructions in the literature accompanying the unit.

WARNING

 INDICATES SAFETY CRITICAL COMPONENTS. FOR CONTINUED SAFETY, REPLACE SAFETY CRITICAL COMPONENTS ONLY BY ORIGINAL COMPONENTS.

Symbol No.	
ACB 1	Strain relief
AC 1	AC cord assembly
C 1	Capacitor
SW 1	Power switch
T 1	Power transformer
ZZ 1	Protective cover

Specification

Parameter		Nominal	Tolerance
Frequency response	20 to 20,000 Hz	±0.5 dB	
Signal-to-noise ratio		90 dB	
Dynamic range		90 dB	
Channel separation	1 kHz	90 dB	
THD	80 kHz filtered	0.005%	
Wow and flutter		Equivalent to crystal quartz	
Audio output level	100% modulation	2V	
Power supply	USA version	120V 60 Hz	±10%
	European version	220V 50 Hz	±10%
Power consumption		30W	±10%
Operating temperature range		25° C	5 to 40° C
Test condition	power supply temperature	As shown above	
	OUTPUT load impedance	25° C	
	test compact disc	50K ohm	
		YEDS-2/3/4/5 SONY	
Dimensions	width 433 mm		
	height 146 mm		
	depth 309 mm		
Weight	7.4 kg		

Alignment procedure

Note: Adjustments #2, #3, #4, #12, #16, #17 are to be performed with the player in the "Stop" mode. All others are to be performed with a disc and the player in the "Play" mode except where noted.

1. Laser Output Adjustment – CAUTION: DO NOT PERFORM THIS ADJUSTMENT WITHOUT THE PROPER POWER METER.

Press "PLAY" then "FF" or "REV" quickly. The laser will continue to focus. Using the power meter, adjust RV101 for 0.3 mW*.

2. Radial Final Stage Offset Adjustment

Connect scope or multimeter to TP111, DC mode, then adjust RV113 for 0 Vdc \pm 100 mV.

3. Forward Motor Offset Adjustment

Connect scope or multimeter to TP502, DC mode, then adjust RV505 for 0 Vdc \pm 50 mV.

4. Focus Final Stage Offset Adjustment

Connect scope or multimeter to TP103, DC mode, then adjust RV107 for 0 Vdc \pm 100 mV.

5. RF Signal Adjustment

Connect scope to TP104, AC mode, then adjust RV104 and RV106 for clear RF signal display.

6. Focus Adjustment for the Laser Head

Connect scope or multimeter to TP103, DC mode, adjust hex screws on the back of the laser head ass'y for 0 Vdc.

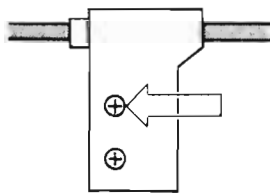

Note: Keep the back of the laser head parallel to the head mounting bracket as possible.

7. Sample Pulse Timing

- Connect scope CH #1 to TP104, AC mode, CH #1 trigger +.
- Connect scope CH #2 to TP107, AC mode, adjust RV108 so that the "up" pulse is centered in the middle diamond (vertically) of the TP104 waveform.

- Connect scope CH #2 to TP106, AC mode, CH #1 trigger -, adjust RV114 so that the "down" pulse is located at leading edge of the middle diamond (vertically) of the TP104 waveform.

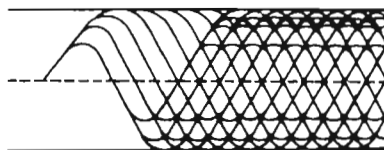

8. DL Signal

- Connect scope to TP105, AC mode.
- Loosen the phillips screws on top of the laser head ass'y.
- Move the laser position to track "0", then adjust by turning the head ass'y and adjusting RV104 for minimum display.

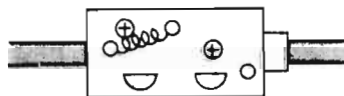

Note: Try to keep the laser head ass'y as parallel to the disc as possible.

- Repeat Step "C" several times.

9. Disc Motor Drive Adjustment

- Connect scope to TP104, AC mode, adjust RV502 full counterclockwise.
- Remember the waveform of "A", then adjust RV502 full clockwise.
- Adjust RV503 so that the waveform that appears now coincides with the waveform of "A".
- Adjust RV502 full counterclockwise, watch for a change in the waveform; if the waveform changes, repeat this adjustment (#10) - if the waveform does not change, continue the alignment procedure.

10. Radial Balance Adjustment

- Connect dual-trace scope to TP108 and TP109, AC mode, then adjust RV109 and RV110 respectively so that waveforms are maximum in amplitude and coincide with each other.
- Put the unit in the "Stop" mode.
- Connect scope/meter to TP110, DC mode, then adjust RV111 for 0 Vdc.

11. Radial Level Adjustment

- Connect Scope to TP111, AC mode, through a bandpass filter, then adjust RV112 for 0.6 Vp-p.
- With the scope still connected to TP111, adjust RV506 for 0.3 Vp-p.

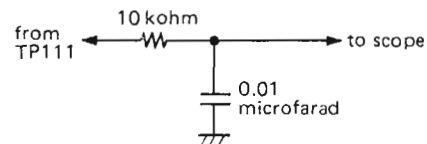

12. Repeat "Radial Final Stage Offset Adjustment"

Connect scope or multimeter to TP111, DC mode, then adjust RV113 for 0 Vdc \pm 100 mV.

13. Disk Motor Drive Circuit Adjustment

Connect scope to TP501, AC mode, then adjust RV501 for a 50% duty cycle.

14. PLL VCO Adjustment

Connect scope or multimeter to TP901, DC mode, then adjust L901 for 5.0 Vdc.

15. Servo Motor Adjustment

Adjust RV504 so that the servo motor moves smoothly.

16. Repeat "Focus Final Stage Offset Adjustment"

Connect scope or multimeter to TP103, DC mode, then adjust RV107 for 0 Vdc \pm 100 mV.

17. Repeat "Forward Motor Offset Adjustment"

Connect scope or multimeter to TP502, DC mode, then adjust RV505 for 0 Vdc \pm 50 mV.

18. Audio Balance Adjustment

Play a 1 kHz L and R signal on test disc, adjust RV901 for channel balance to maximum at the audio outputs (0.45 dB).

*** Important**

Use care not to exceed 0.32 mW. Even a momentary excess of the light output beyond this wattage must be avoided.

Chassis layout

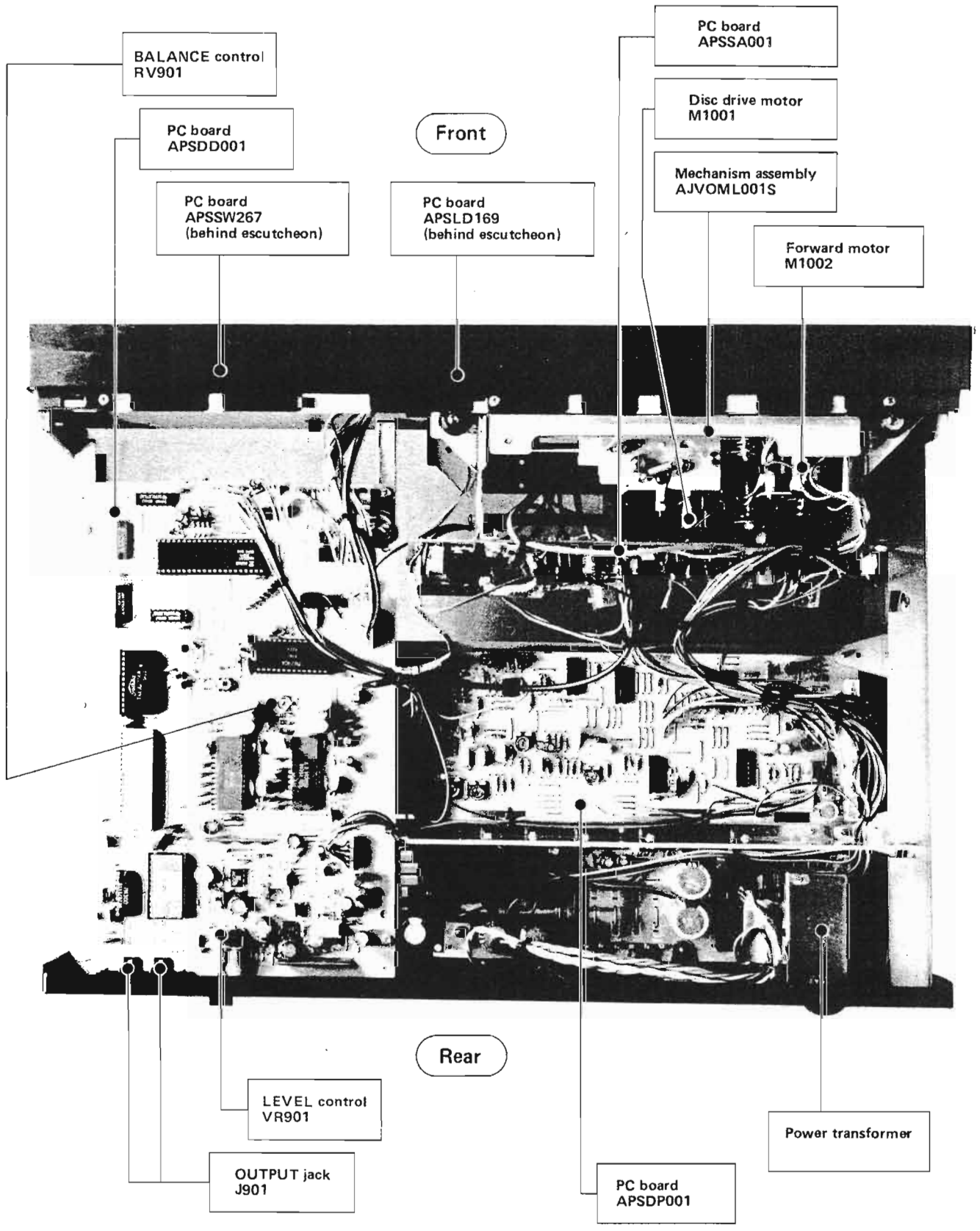

Functional block diagram

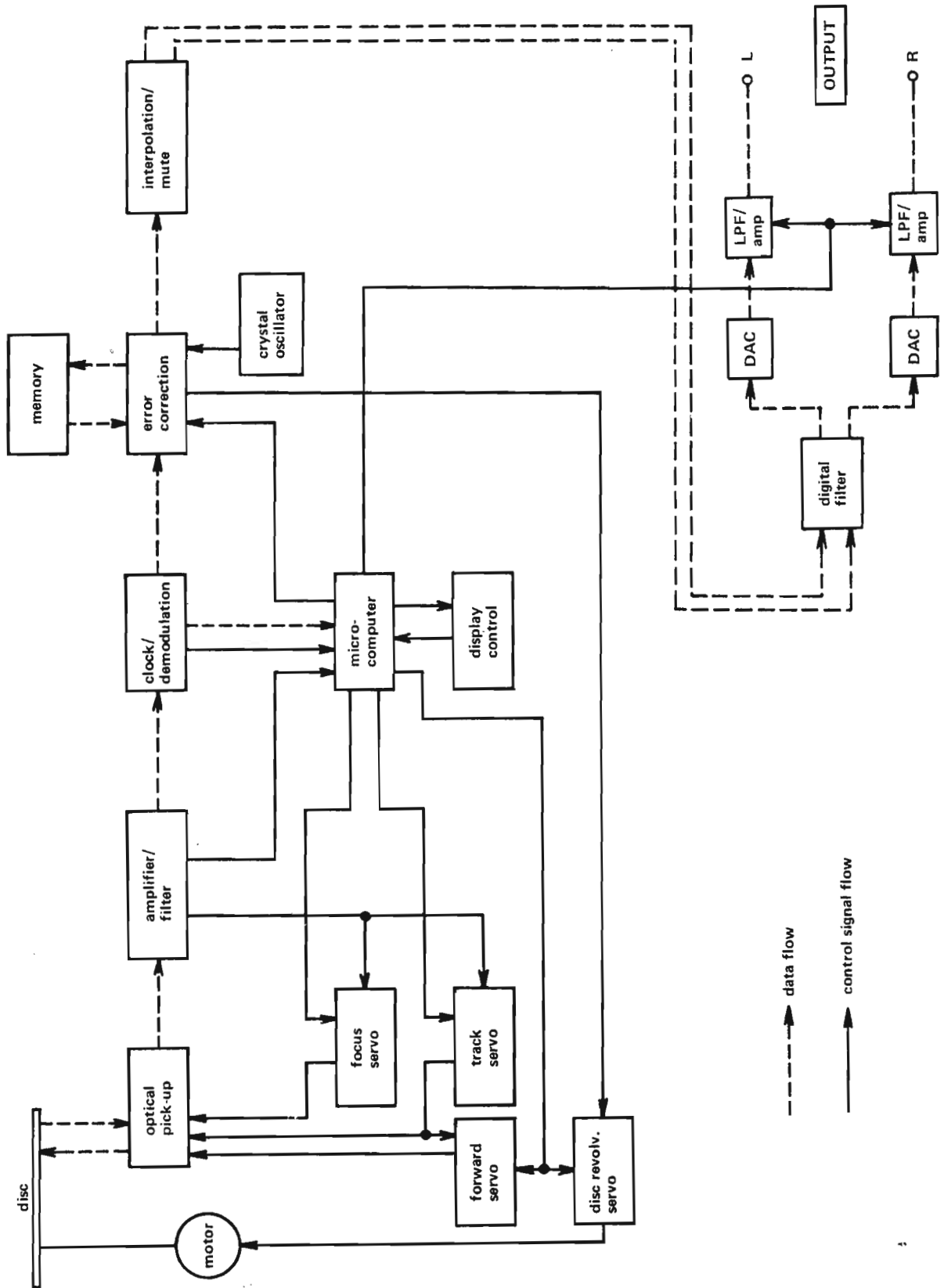

Test point scope check

PC board PSSA001COX

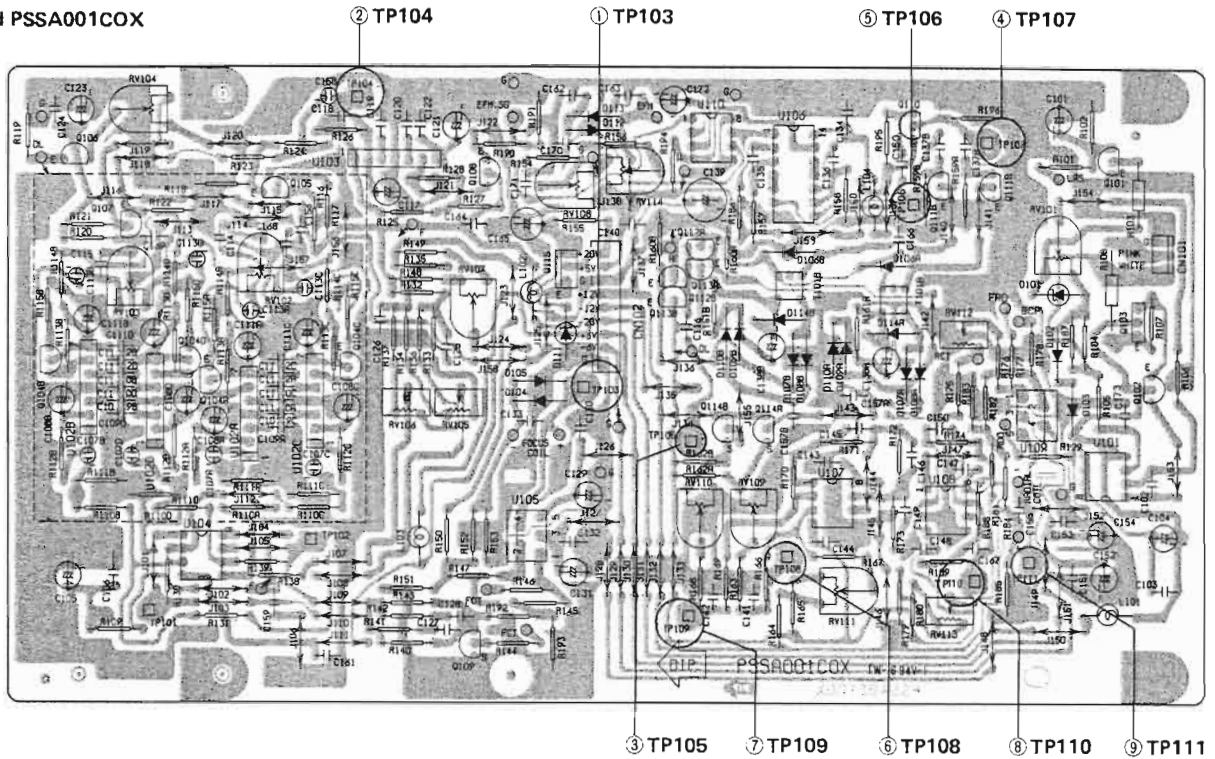

① TP103 (0.1msec/div. 50mV/div.)

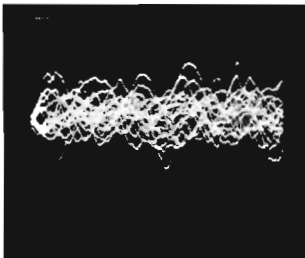

④ TP107 (0.5μsec/div. 0.1V/div.) lower

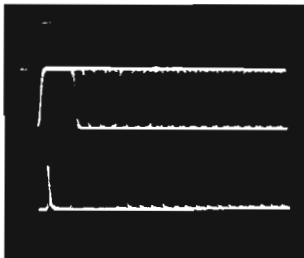

⑧ TP110 (1msec/div. 5mV/div.)

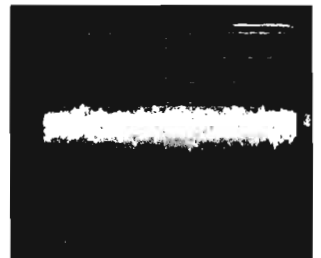

② TP104 (0.5μsec/div. 5mV/div.)

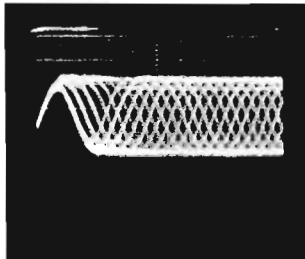

⑤ TP106 (0.5μsec/div. 0.1V/div.) lower

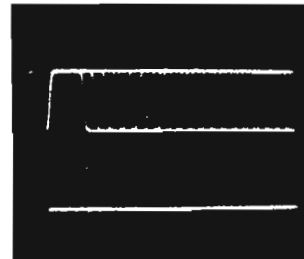

⑨ TP111 (0.5msec/div. 20mV/div.)



③ TP105 (0.5μsec/div. 5mV/div.)

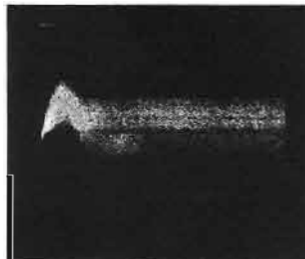

⑥ TP108 (2msec/div. 20mV/div.) upper

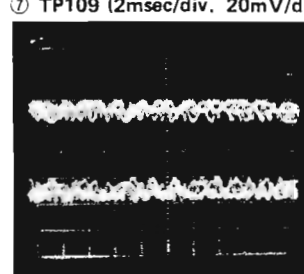

⑦ TP109 (2msec/div. 20mV/div.) lower

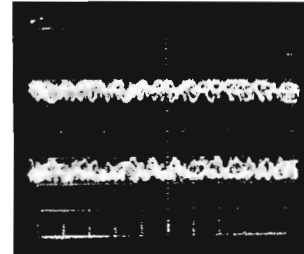

PC board PSDP001COX

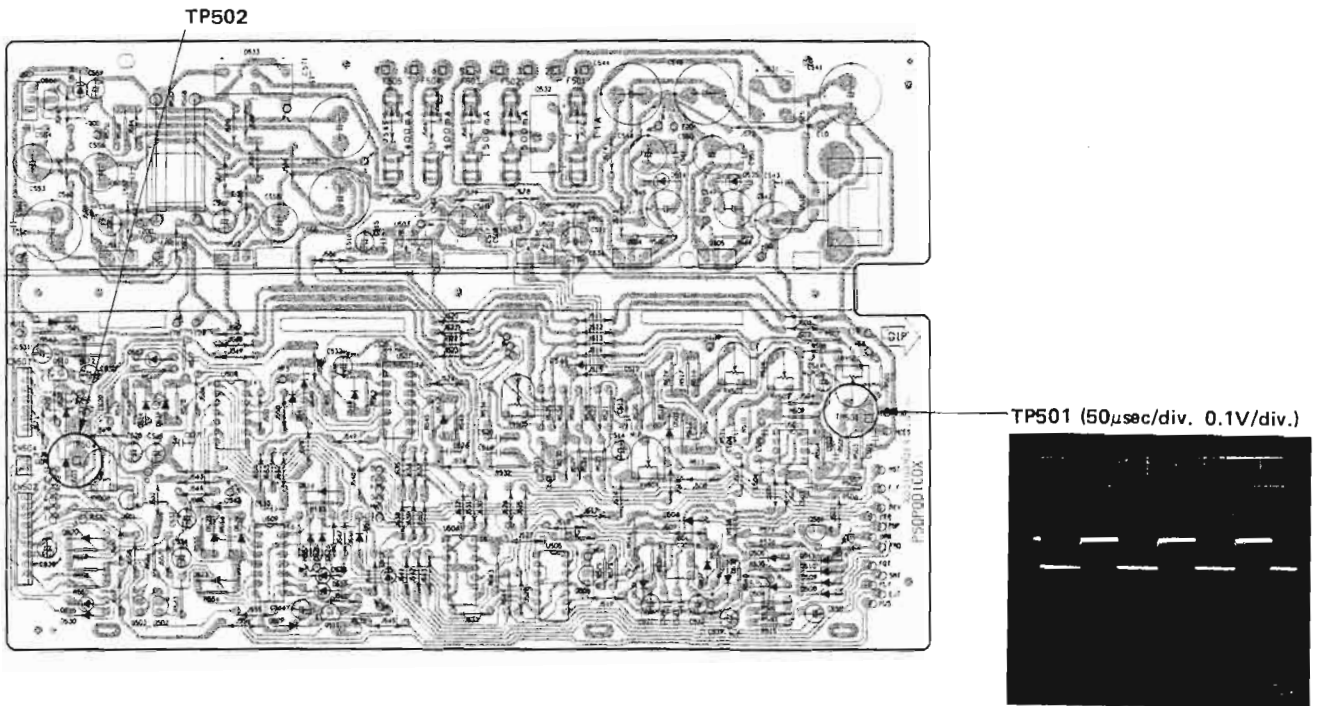

PC board PSDD001COX (See next page)

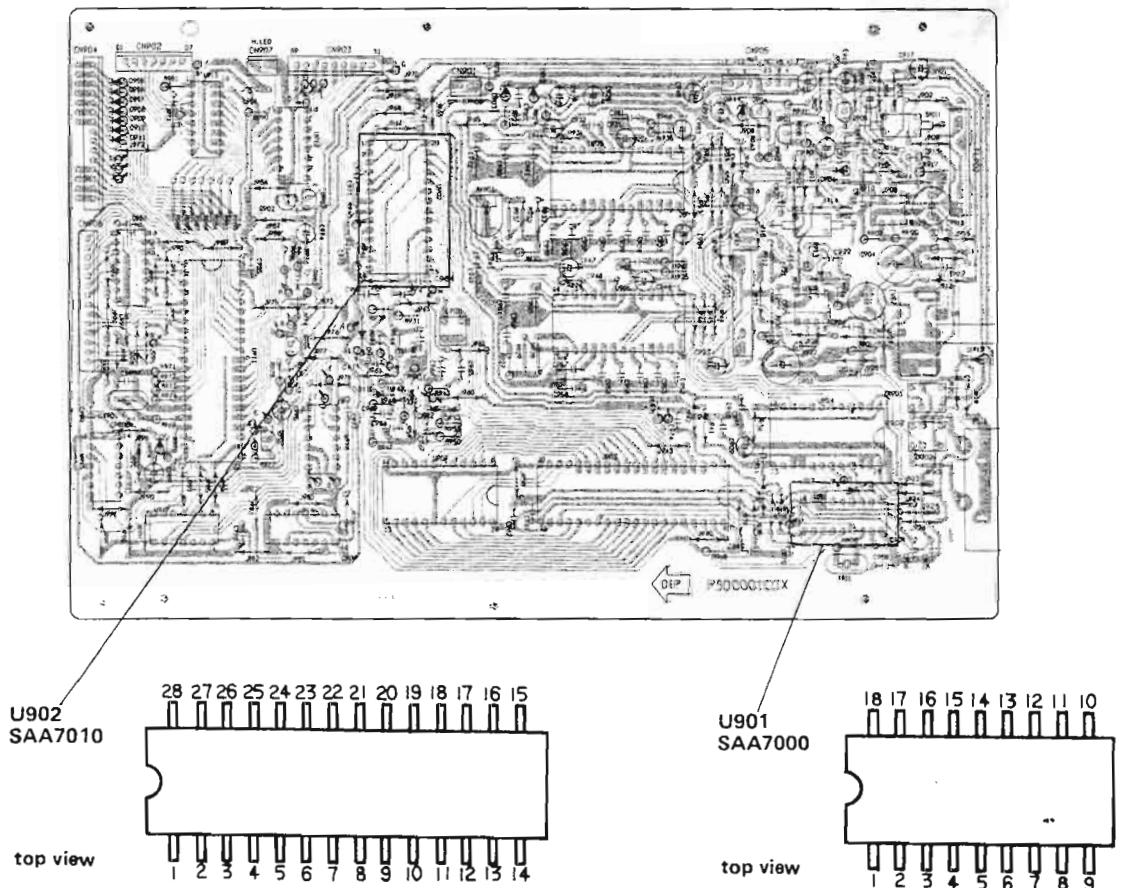

Pin 11 (5 μ sec/div. 0.2V/div.)

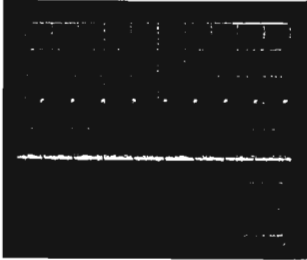

U901
SAA7000
(M4300)

Pin 14 (0.2 μ sec/div. 0.2V/div.)

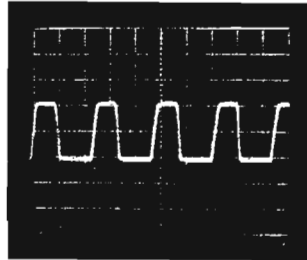

U901
SAA7000
(M4300)

Pin 6 (0.2 μ sec/div. 0.2V/div.)

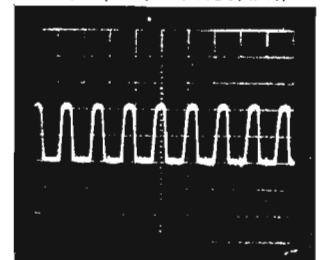

U904
SAA7030
(M4550)

Pin 12 (20 μ sec/div. 0.2V/div.)

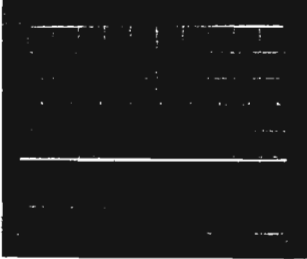

U901
SAA7000
(M4300)

Pin 15 (0.2 μ sec/div. 0.2V/div.)

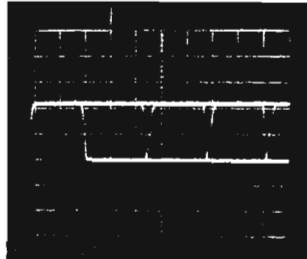

U901
SAA7000
(M4300)

Pin 10 (0.2 μ sec/div. 0.2V/div.)

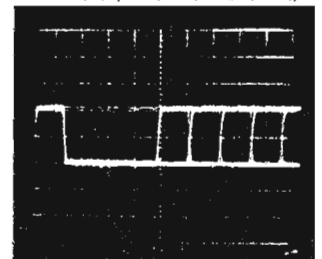

U904
SAA7030
(M4550)

Pin 13 (0.5 μ sec/div. 0.2V/div.)

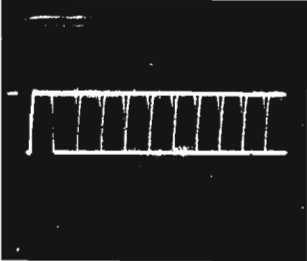

U901
SAA7000
(M4300)

Pin 3 (0.2 μ sec/div. 0.2V/div.)

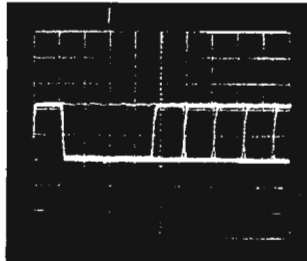

U904
SAA7030
(M4550)

Pin 22 (0.2 μ sec/div. 0.2V/div.)

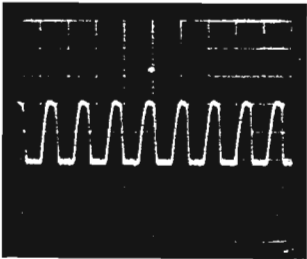

U902
SAA7010
(M4290A)

Pin 26 (0.2 μ sec/div. 0.2V/div.)

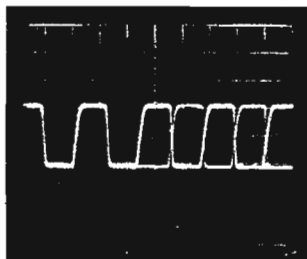

U902
SAA7010
(M4290A)

Pin 23 (0.2 μ sec/div. 0.2V/div.)

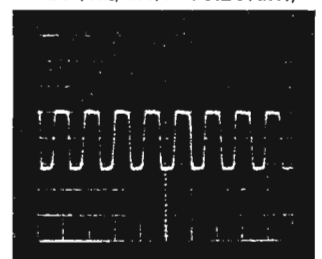

U903
SAA7020
(M4280)

Pin 24 (0.1 μ sec/div. 0.2V/div.)

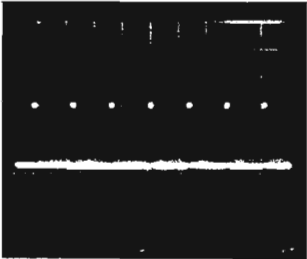

U902
SAA7010
(M4290A)

Pin 27 (0.2 μ sec/div. 0.2V/div.)

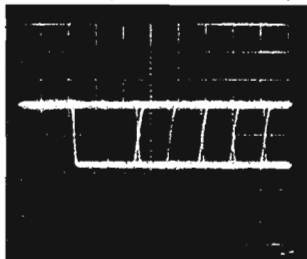

U902
SAA7010
(M4290A)

Pin 27 (0.2 μ sec/div. 0.2V/div.)

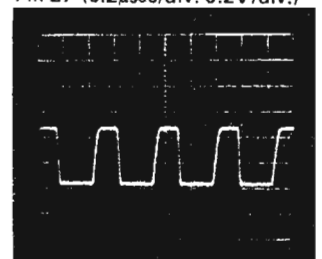

U903
SAA7020
(M4280)

Pin 25 (2 μ sec/div. 0.2V/div.)

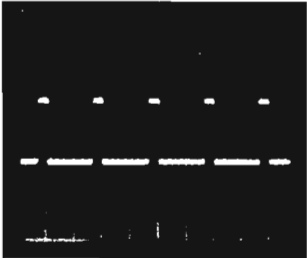

U902
SAA7010
(M4290A)

Pin 2 (0.1 μ sec/div. 0.2V/div.)

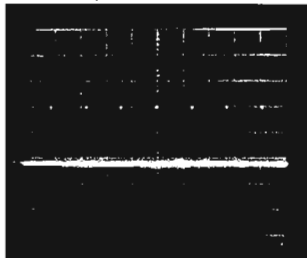

U903
SAA7020
(M4280)

Pin 37 (0.2 μ sec/div. 0.2V/div.)

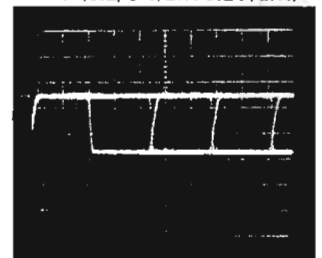

U903
SAA7020
(M4280)

Semiconductor basing information

All ICs top view except those side viewed.

U101 }
U104 } NJM4558D
U107 }
U108 }
U501 }
U504 }

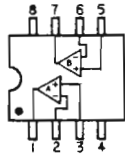

1 A OUTPUT 5 8* INPUT
2 A- INPUT 6 8- INPUT
3 A* INPUT 7 8 OUTPUT
4 V-

U910: TC4028BP

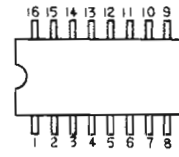

1 Q_a OUTPUT 9 Q_c OUTPUT
2 Q_b OUTPUT 10 A INPUT
3 Q_c OUTPUT 11 D INPUT
4 Q_d OUTPUT 12 C INPUT
5 Q_e OUTPUT 13 B INPUT
6 Q_f OUTPUT 14 Q_i OUTPUT
7 Q_g OUTPUT 15 Q_j OUTPUT
8 V_{SS} 16 V_{DD}

U110: LA1222

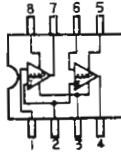

1 Amp I INPUT
2 BIAS
3 G
4 Amp II OUTPUT
5 Amp II OUTPUT (V_{CC})
6 Amp II INPUT
7 Amp I OUTPUT
8 V_{CC}

U102(A-D) } TA7302P
U103 }



1 + INPUT
2 - INPUT
3 BIAS
4 GND
5 FILTER
6 OPEN COLLECTOR OUTPUT
7 V_{CC}

U908 } TL072
U909 } (NJM4556)

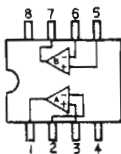

1 A OUTPUT 5 8* INPUT
2 A- INPUT 6 8- INPUT
3 A* INPUT 7 8 OUTPUT
4 V_{CC}- 8 V_{CC}*

U505 }
U506 } TC4066BP

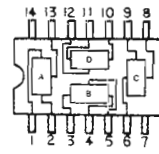

1 A IN/OUT 8 C IN/OUT
2 A OUT/IN 9 C OUT/IN
3 B OUT/IN 10 D OUT/IN
4 B IN/OUT 11 D IN/OUT
5 B C_{IN} 12 D C_{IN}
6 C C_{IN} 13 A C_{IN}
7 V_{SS} 14 V_{CC}

U106 } SN74LS04N
U916 }

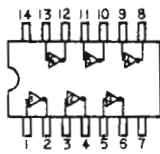

1 1 INPUT 8 4 OUTPUT
2 1 OUTPUT 9 4 INPUT
3 2 INPUT 10 5 OUTPUT
4 2 OUTPUT 11 5 INPUT
5 3 INPUT 12 6 OUTPUT
6 3 OUTPUT 13 6 INPUT
7 GND 14 V_{CC}

U507 }
U509 } TC409UBP
(HD 14049UBP)

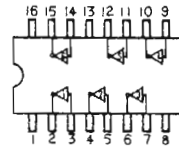

1 V_{CC} 9 4 INPUT
2 1 OUTPUT 10 4 OUTPUT
3 1 INPUT 11 5 INPUT
4 2 OUTPUT 12 5 OUTPUT
5 2 INPUT 13 NC
6 3 OUTPUT 14 6 INPUT
7 3 INPUT 15 6 OUTPUT
8 V_{SS} 16 V_{DD}

U917: SN74LS11N

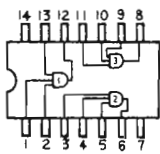

1 1 INPUT 8 3 OUTPUT
2 1 INPUT 9 3 INPUT
3 2 INPUT 10 3 INPUT
4 2 INPUT 11 3 INPUT
5 2 INPUT 12 1 OUTPUT
6 2 OUTPUT 13 1 INPUT
7 GND 14 V_{CC}

U508: TC4011BP

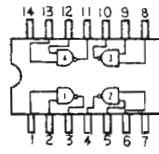

1 1 INPUT 8 3 INPUT
2 1 INPUT 9 3 INPUT
3 1 OUTPUT 10 3 OUTPUT
4 2 OUTPUT 11 4 OUTPUT
5 2 INPUT 12 4 INPUT
6 2 INPUT 13 4 INPUT
7 V_{SS} 14 V_{DD}

U915: SN74LS74N

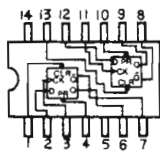

1 1 CLR 8 2Q
2 1D 9 2P
3 1CK 10 2PR
4 1PR 11 2CK
5 1Q 12 2D
6 1Q 13 2CLR
7 GND 14 V_{CC}

U105 }
U109 } μPC1238V
U502 }
U503 }



1 INPUT
2 NF8
3 -V_{CC}
4 OUTPUT
5 +V_{CC}

U914: M74LS193P

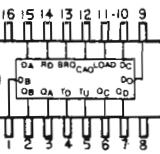

1 D_a 9 D_c
2 Q_a 10 D_c
3 Q_a 11 LOAD
4 T_a 12 CA0
5 T_b 13 BRO
6 Q_c 14 R_D
7 Q_b 15 D_A
8 GND 16 V_{CC}

U510: μA7805UC
U511: μA7812UC



1 INPUT
2 COMMON
3 OUTPUT

U913: 8A618

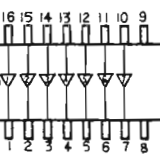

1 1 OUTPUT 9 GND
2 2 OUTPUT 10 7 INPUT
3 3 OUTPUT 11 6 INPUT
4 4 OUTPUT 12 5 INPUT
5 5 OUTPUT 13 4 INPUT
6 6 OUTPUT 14 3 INPUT
7 7 OUTPUT 15 2 INPUT
8 V_{CC} 16 1 INPUT

U512: μA7912UC



1 COMMON
2 INPUT
3 OUTPUT

U912: M54517P

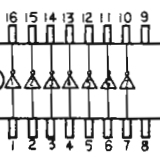

1 1 INPUT 9 NC
2 2 INPUT 10 7 OUTPUT
3 3 INPUT 11 6 OUTPUT
4 4 INPUT 12 5 OUTPUT
5 5 INPUT 13 4 OUTPUT
6 6 INPUT 14 3 OUTPUT
7 7 INPUT 15 2 OUTPUT
8 GND 16 1 OUTPUT

U901: SAA7000
(M4300)

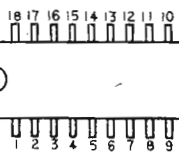

1 V_{BB} 10 V_{DD2}
2 FSEC 11 STR2
3 CLEC 12 STR1
4 DAEC 13 DLCF
5 UNEC 14 CLCF
6 CLOX 15 DRFC
7 XTAL2 16 14/16
8 XTAL1 17 TEST
9 V_{SS} 18 V_{DD1}

U904: SAA7030 (M4550)

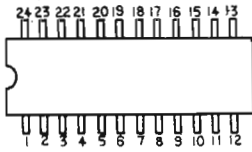

- | | |
|---------|---------|
| 1 VBB | 13 VDD2 |
| 2 OS | 14 NC |
| 3 DLFD | 15 TINR |
| 4 NC | 16 TINL |
| 5 NC | 17 DRFC |
| 6 CLFD | 18 CLCF |
| 7 LAT | 19 CLOX |
| 8 NC | 20 DLCF |
| 9 NC | 21 STR1 |
| 10 DPFD | 22 RT |
| 11 OB | 23 TE |
| 12 VSS | 24 VDD1 |

U903: SAA7020 (M4280)

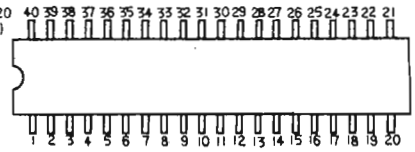

- | | | | |
|-----------|---------|---------|---------|
| 1 VBB | 11 A2ER | 21 VDD2 | 31 D4ER |
| 2 FSEC | 12 A3ER | 22 TEST | 32 D3ER |
| 3 C1 FLAG | 13 A4ER | 23 CLOX | 33 D2ER |
| 4 MCES | 14 A5ER | 24 WEER | 34 D1ER |
| 5 DADE | 15 A6ER | 25 OEER | 35 DOER |
| 6 CLDE | 16 A7ER | 26 CEER | 36 UNEC |
| 7 SSDE | 17 A8ER | 27 CLEC | 37 DAEC |
| 8 FSDE | 18 A9ER | 28 DTER | 38 GAP |
| 9 A0ER | 19 AAER | 29 D6ER | 39 SMSE |
| 10 A1ER | 20 VSS | 30 D5ER | 40 VDD1 |

U902: SAA7010 (M4290)

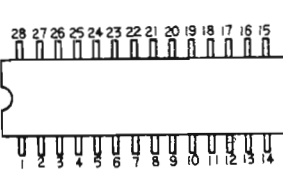

- | | |
|--------------|---------------|
| 1 VBB | 15 VDD2 |
| 2 SDATA | 16 OA1 |
| 3 SBCL | 17 OA2 |
| 4 SWCL | 18 OA3 |
| 5 P | 19 VSS (ANAL) |
| 6 HFD | 20 VCO1 |
| 7 HF1 | 21 VCO2 |
| 8 HF2 | 22 CCFM |
| 9 FB | 23 FD |
| 10 FB | 24 FSDE |
| 11 DEFM | 25 SSDE |
| 12 PD2 | 26 CLDE |
| 13 PD1 | 27 DADE |
| 14 VSS (DIG) | 28 VDD1 |

U907: TMM2016P-2

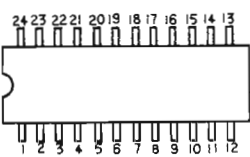

- | | |
|---------|---------|
| 1 A7 | 13 I/O4 |
| 2 A6 | 14 I/O5 |
| 3 A5 | 15 I/O6 |
| 4 A4 | 16 I/O7 |
| 5 A3 | 17 I/O8 |
| 6 A2 | 18 CS |
| 7 A1 | 19 A10 |
| 8 A0 | 20 OE |
| 9 I/O1 | 21 WE |
| 10 I/O2 | 22 A9 |
| 11 I/O3 | 23 A8 |
| 12 GND | 24 Vcc |

U905 } TDA1540
U906 }

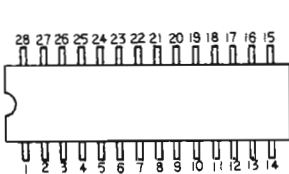

- | | |
|--------------|--------------|
| 1 DATA INPUT | 15 CURRENT R |
| 2 LATCH | 16 CURRENT R |
| 3 VOLT R | 17 CURRENT R |
| 4 V1 | 18 DECOUP C |
| 5 FCA | 19 DECOUP C |
| 6 GROUND | 20 DECOUP C |
| 7 V1 | 21 DECOUP C |
| 8 OSC C | 22 AF OUT |
| 9 OSC C | 23 DECOUP C |
| 10 VOLT R | 24 DECOUP C |
| 11 V1 | 25 DECOUP C |
| 12 DECOUP C | 26 VOLT R |
| 13 DECOUP C | 27 VOLT R |
| 14 DECOUP C | 28 CLOCK IN |

U911: MB88401-P

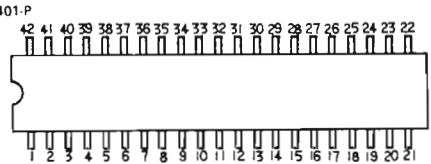

- | | | | |
|--------|----------|----------|--------|
| 1 R4 | 12 K6 | 22 SC/TO | 33 P6 |
| 2 R5 | 13 K1 | 23 SI | 34 P1 |
| 3 R6 | 14 K2 | 24 SO | 35 P2 |
| 4 R7 | 15 K3 | 25 O6 | 36 P3 |
| 5 R8 | 16 EX | 26 O1 | 37 R6 |
| 6 R9 | 17 X | 27 O2 | 38 R1 |
| 7 R10 | 18 RESET | 28 O3 | 39 R2 |
| 8 R11 | 19 IRO | 29 O4 | 40 R3 |
| 9 R12 | 20 TC | 30 O5 | 41 Vm |
| 10 R13 | 21 Vss | 31 O6 | 42 Vcc |
| 11 R14 | | 32 O7 | |

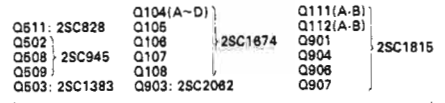

Q605 } 2SA768
Q507 }

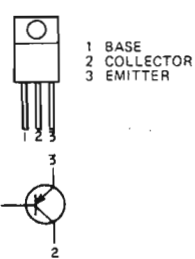

Q103: 2SA794

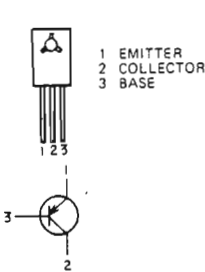

Q115 } 2SD313
Q504 }

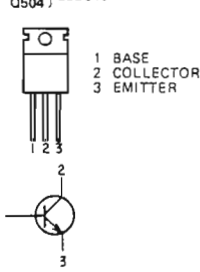

Q101 }
Q110 }
Q113(A-B) } 2SA1015
Q506 }
Q510 }
Q902 }
Q905 }
Q102: 2SA564

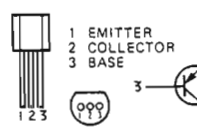

Q114(A-B): 2SK121

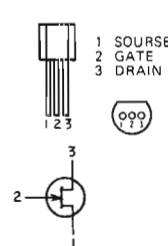

Q109 } 2SK246
Q501 }

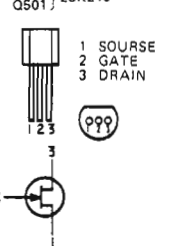

D101: MA1082
D536: MA1180M

- | | |
|-----------|------------------------|
| D102 | D501, D516, D530, D901 |
| D103 | D504, D517, D537, D904 |
| D106(A-B) | D505, D518, D538, D905 |
| D107(A-B) | D506, D520, D539, D906 |
| D108(A-B) | D507, D521, D540, D907 |
| D109(A-B) | D508, D522, D541, D908 |
| D110(A-B) | D509, D523, D542, D909 |
| D112 | D510, D524, D910 |
| D113 | D511, D525, D911 |
| | D512, D526, D915 |
| | D514, D529, |

D903: RD2-4EC
D513 }
D515 } RD5.1EB1
D519 }
D527 }
D528 }
D902 }
D914 }



D534 } RD6.8EB2
D535 }



D531: S2VB



D532 } S1RBA20
D533 }

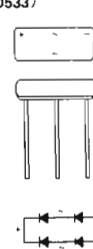

D912 } SVC321SP
D913 }

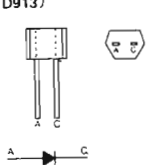

D104 }
D105 } EM12
D502 }
D503 }

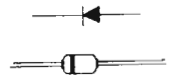

(A) Laser circuit failure

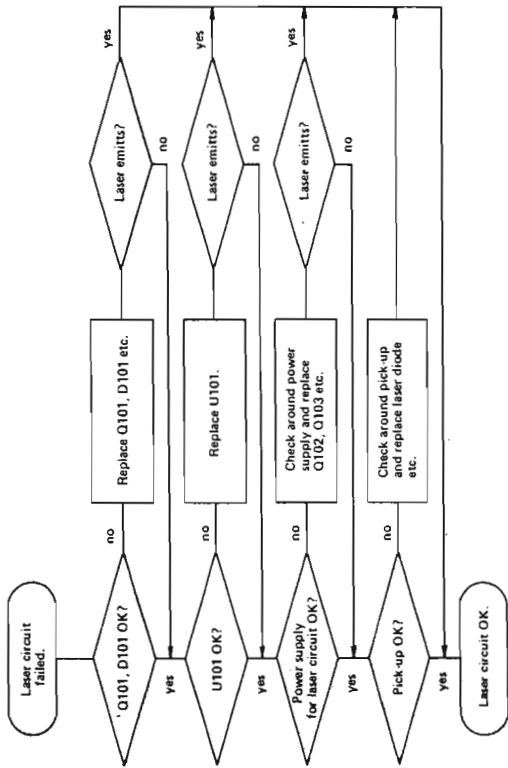

(C) RF circuit failure

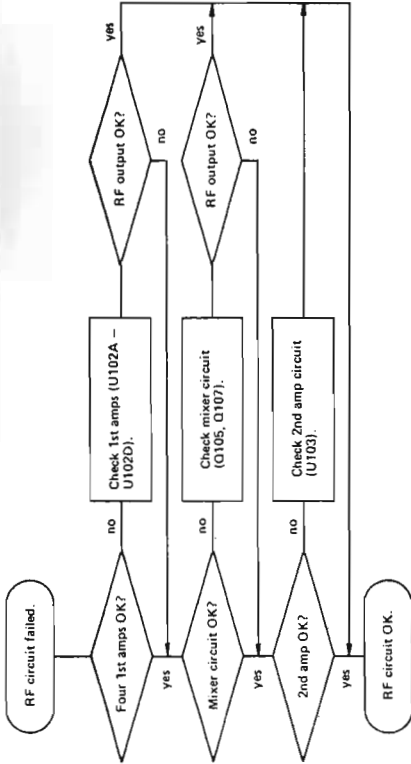

(B) Focus circuit failure

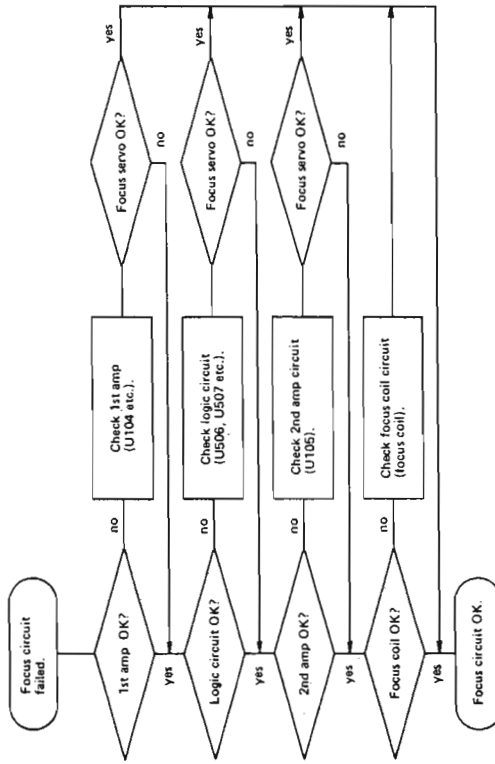

(D) Tracking circuit failure

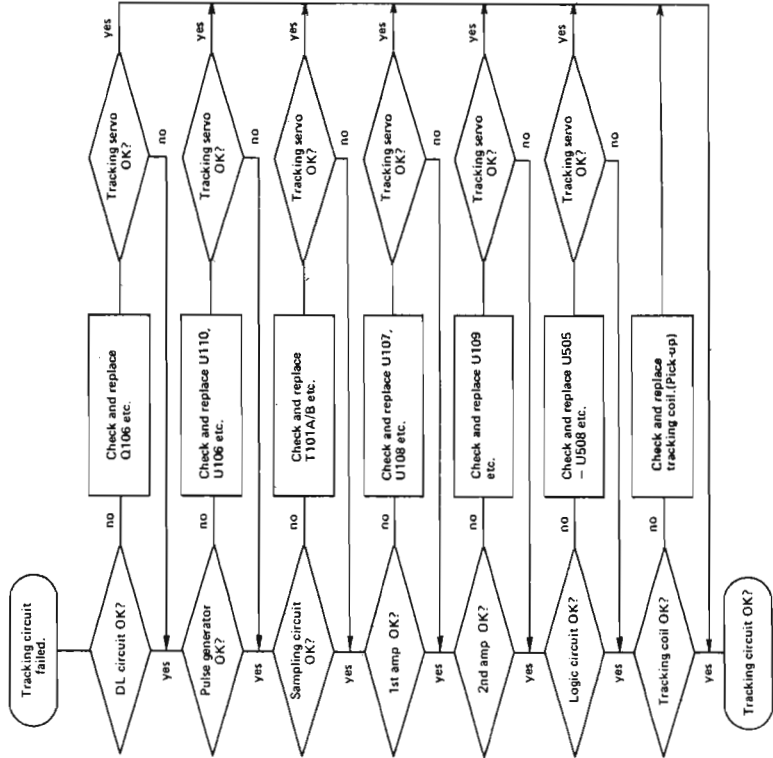

PC board layout

APSSA001AD
APSSA001BD See page 30 for part number information.

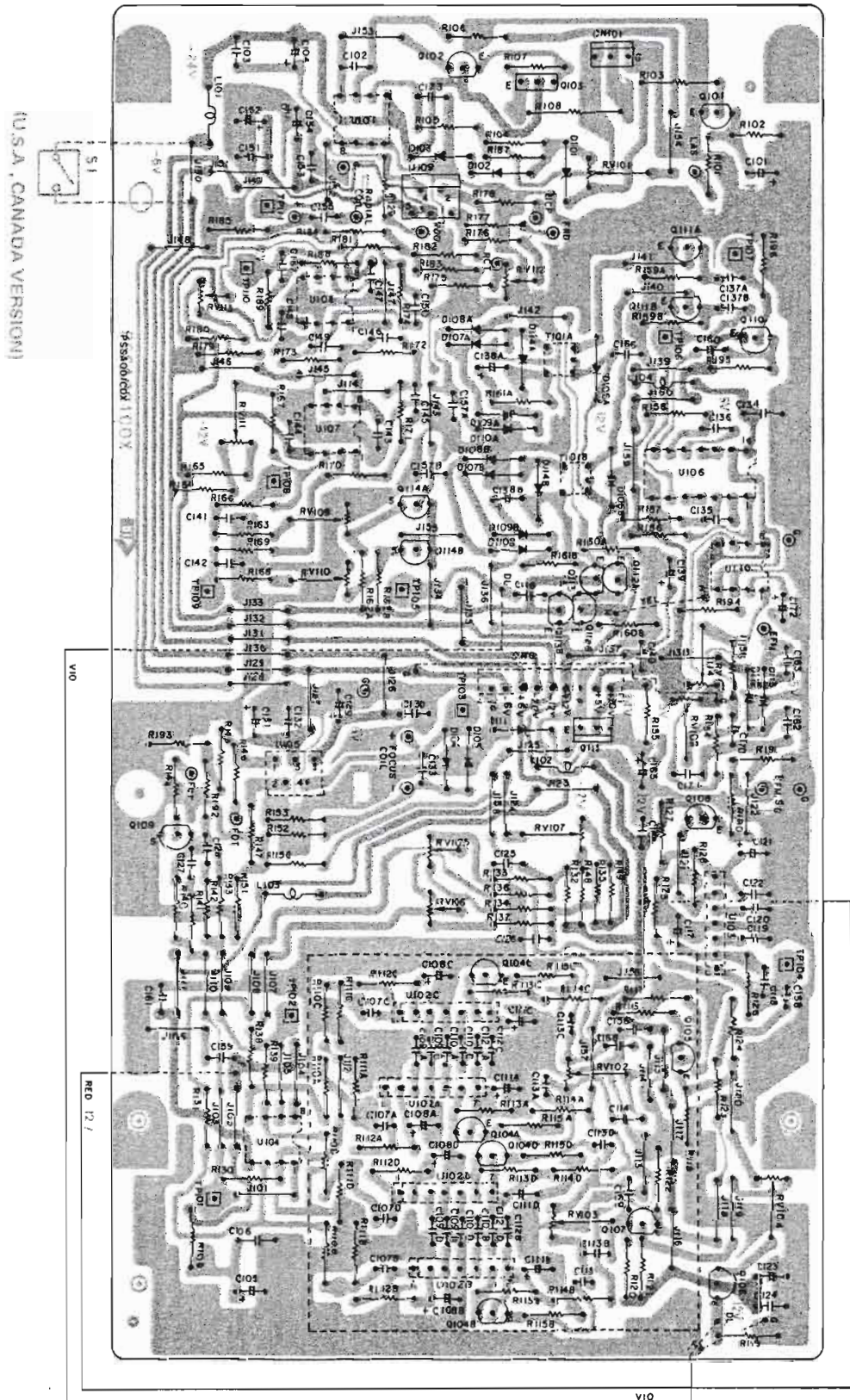

APSDP001CD
APSDP001AD See page 30 for part number information.

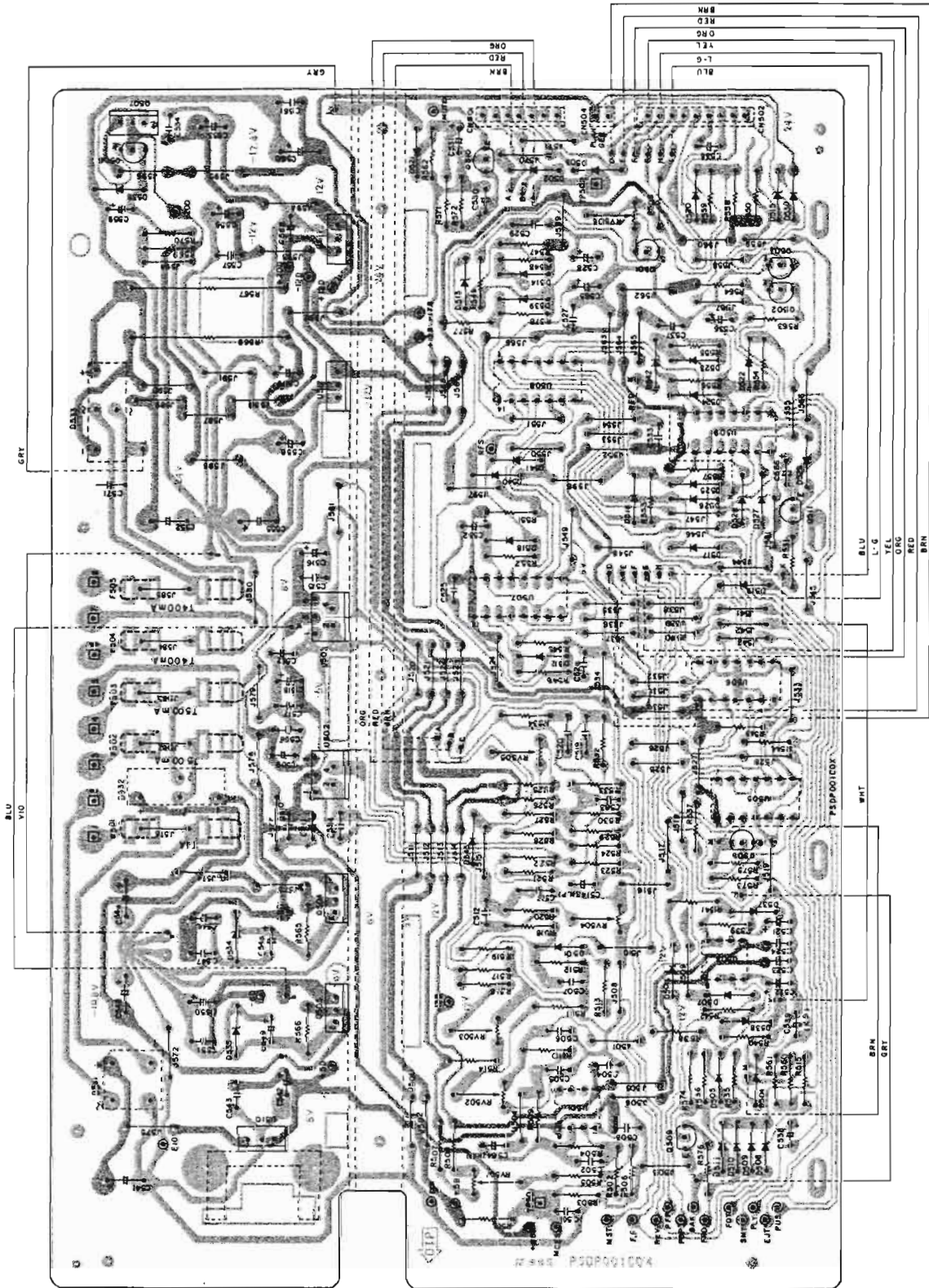

NOTE: On the 307G lot (serial number reference), the mute circuit is broken across the other side of the DPDT power switch. To do this on previous lots, cut the runners on the 900 PC board as shown on Page 16 and connect jumpers at either side of the break to go across the power switch. The side to be used has one side of the AC cord connected to the red wire of the transformer primary (page 19). This connection should be lifted and terminated in a wire nut. The jumpers should then be connected across that side of the switch such that the path is completed when the power is switched on.

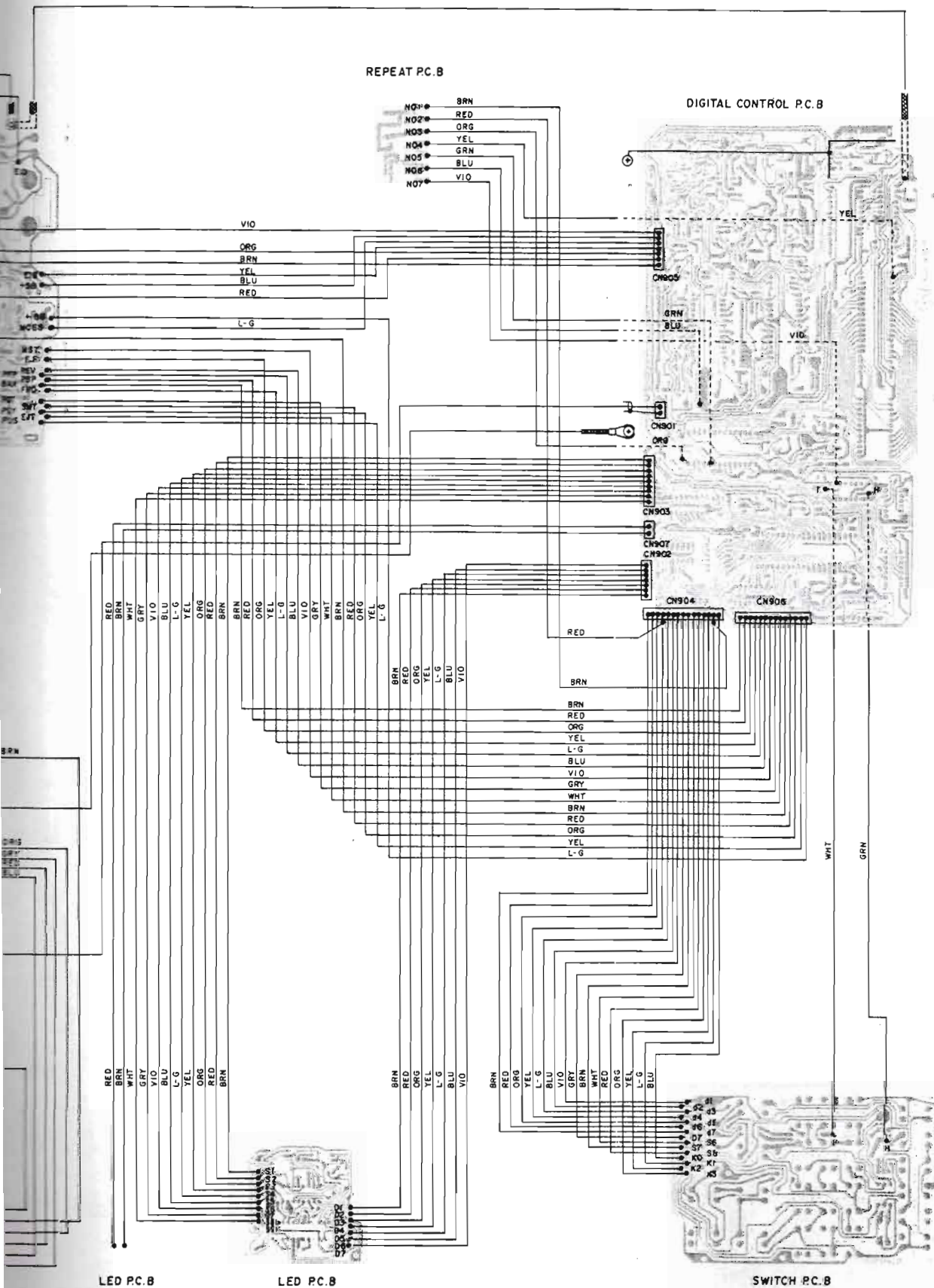

Wiring diagram (2)

Serial Nos. 307G1071 ~ 307G1670

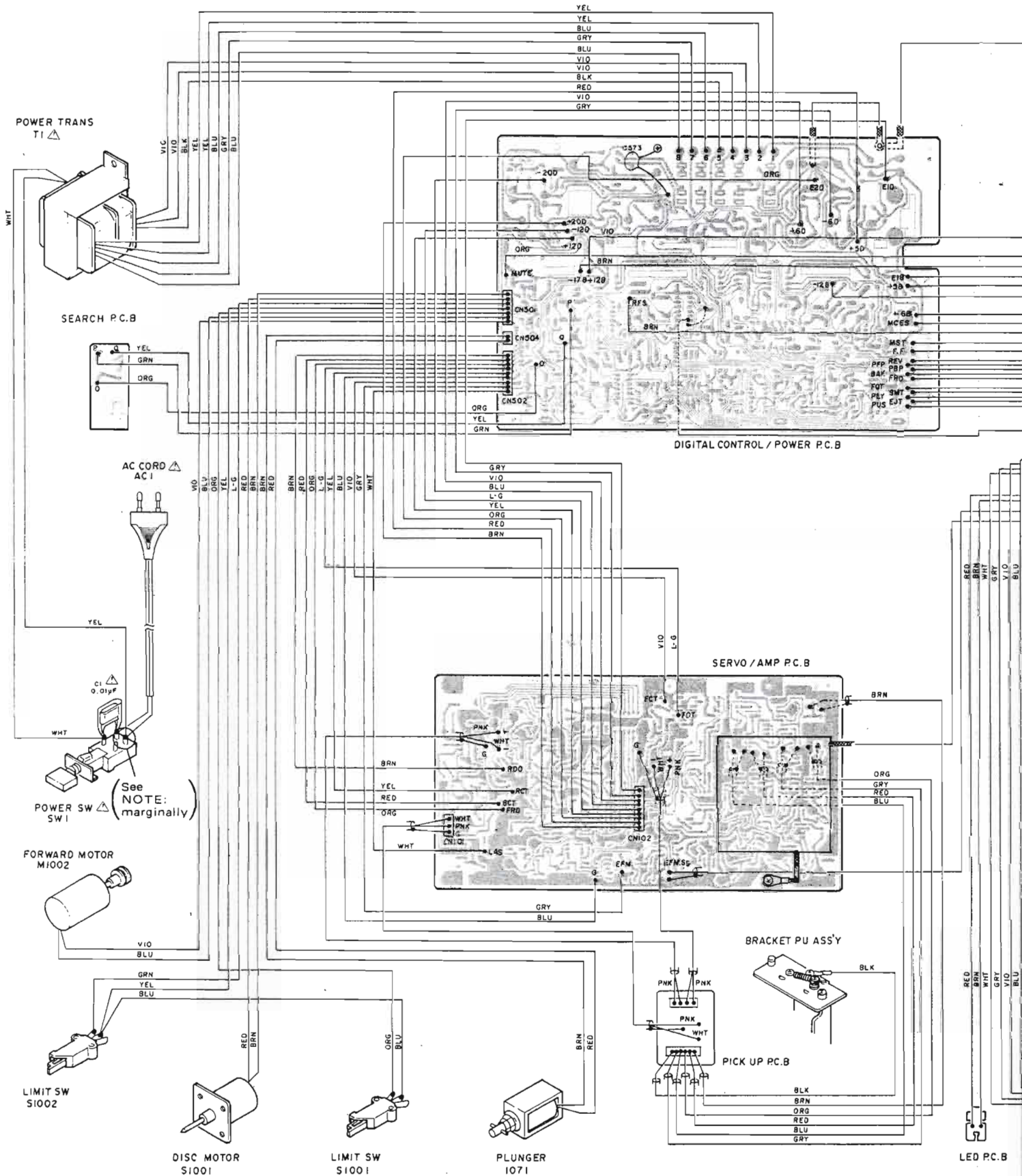

NOTE: On the 307G lot (serial number reference), the mute circuit is broken across the other side of the DPDT power switch. To do this on previous lots, cut the runners on the 900 PC board as shown on Page 16 and connect jumpers at either side of the break to go across the power switch. The side to be used has one side of the AC cord connected to the red wire of the transformer primary (page 19). This connection should be lifted and terminated in a wire nut. The jumpers should then be connected across that side of the switch such that the path is completed when the power is switched on.

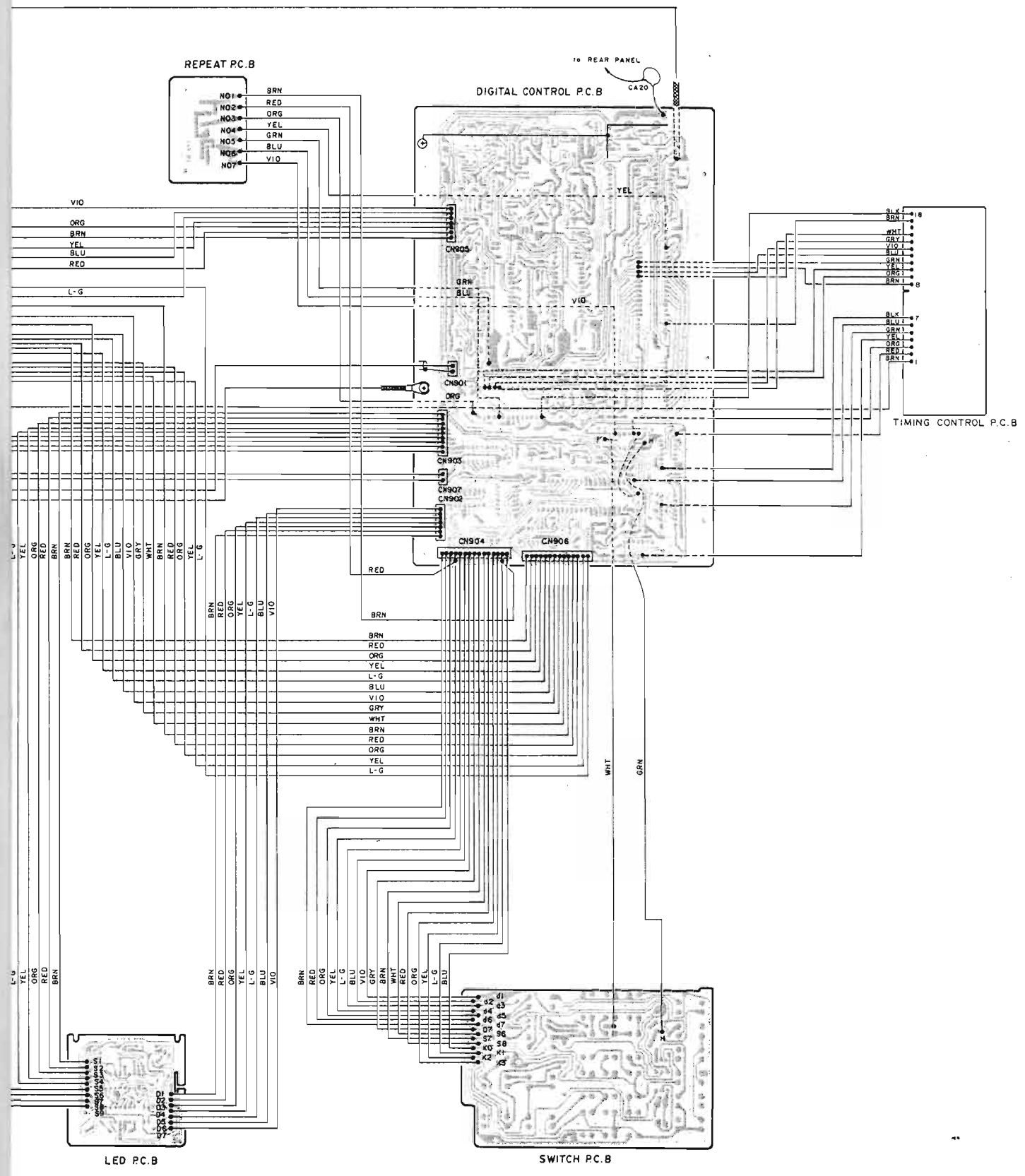

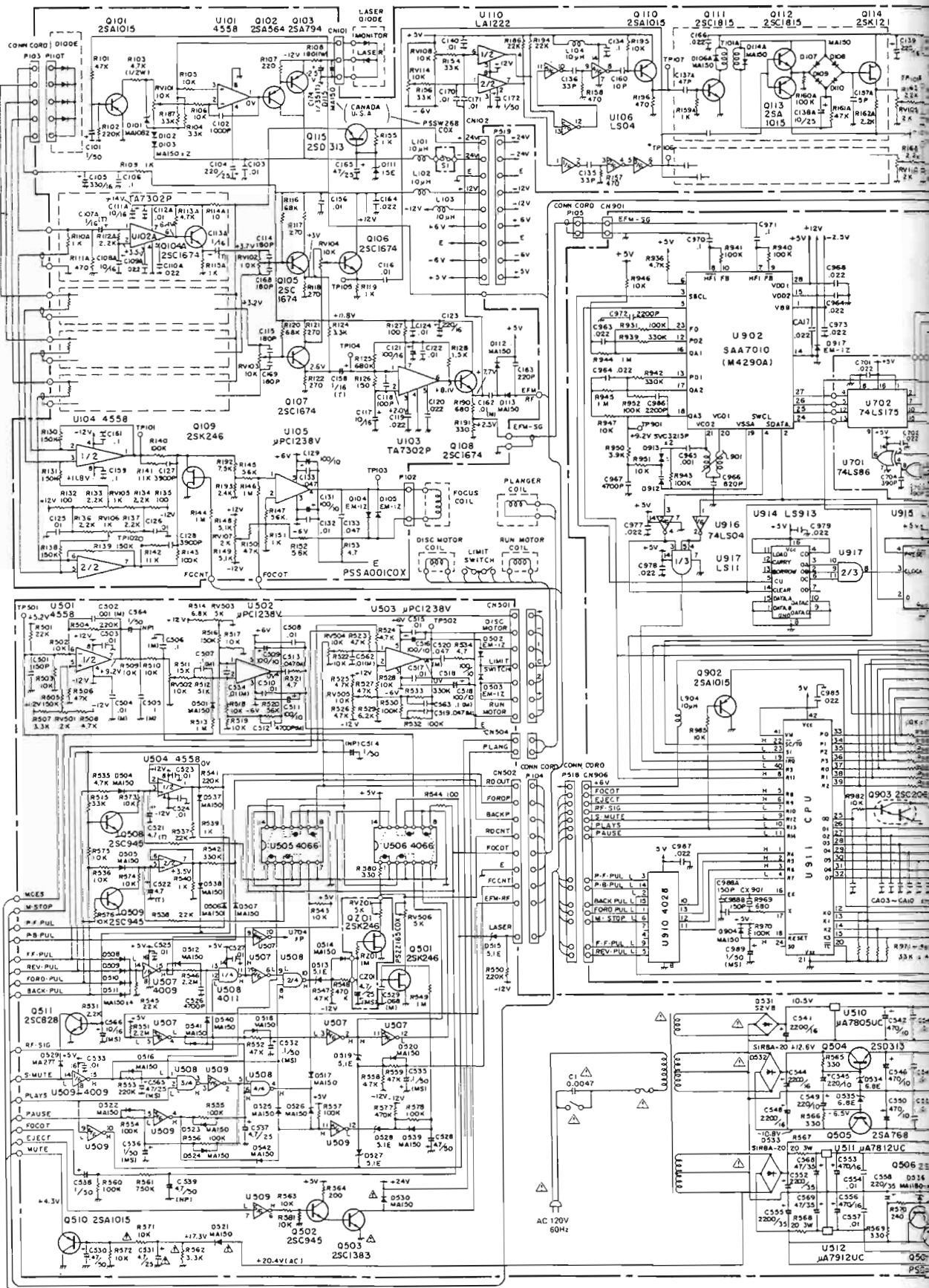

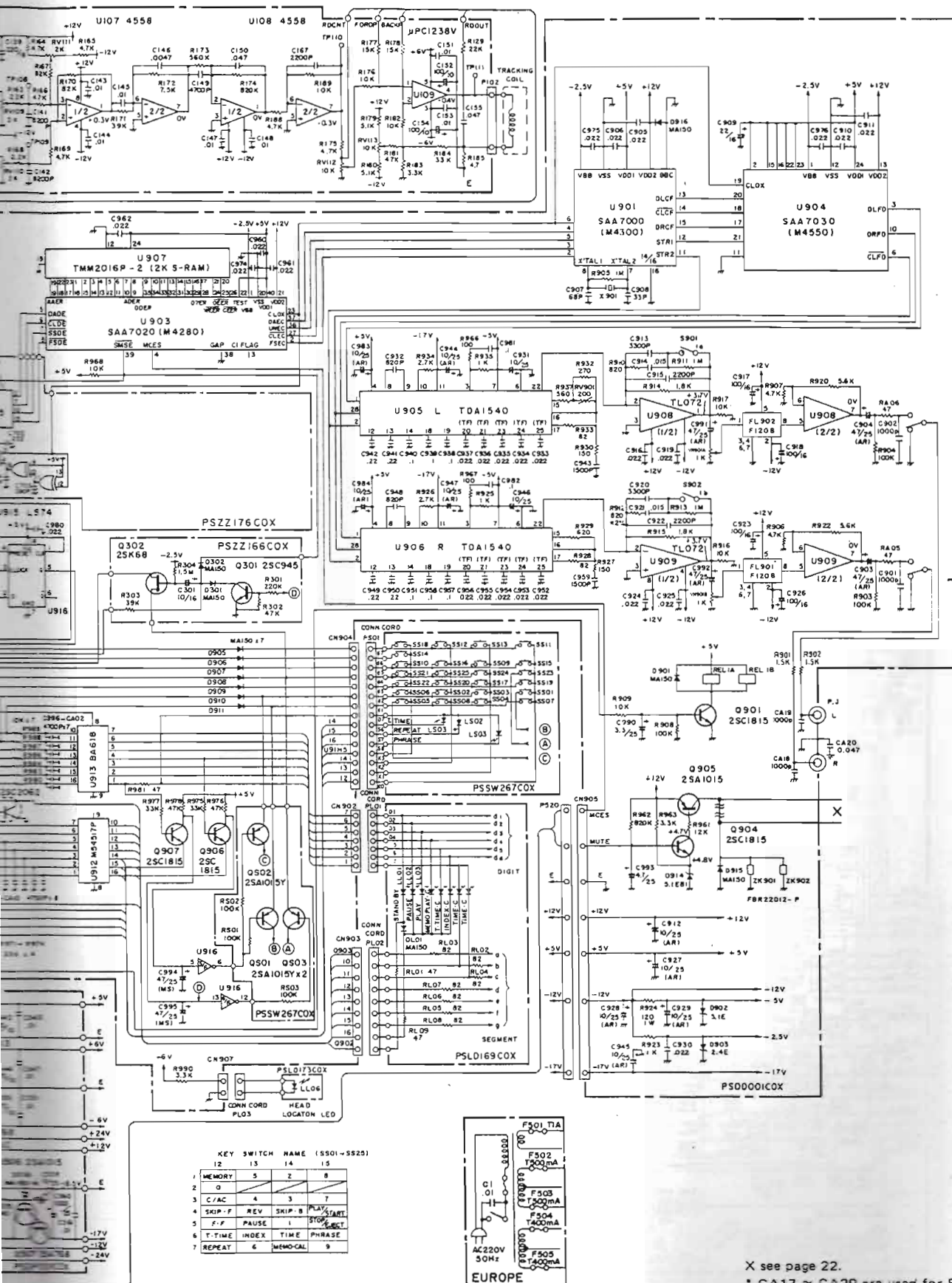

KEY SWITCH NAME (S501-S525)

12	13	14	15
1	MEMORY	5	2
2	0	4	3
3	C/A/C	4	3
4	SKIP-F	REV	SKIP-B
5	F.P	PAUSE	1
6	T-TIME	INDEX	TIME
7	REPEAT	6	MEMO-CL
		8	9

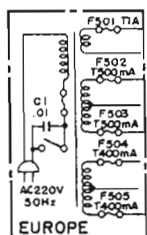

X see page 22.
 * CA17 ~ CA20 are used for EUROPE version.

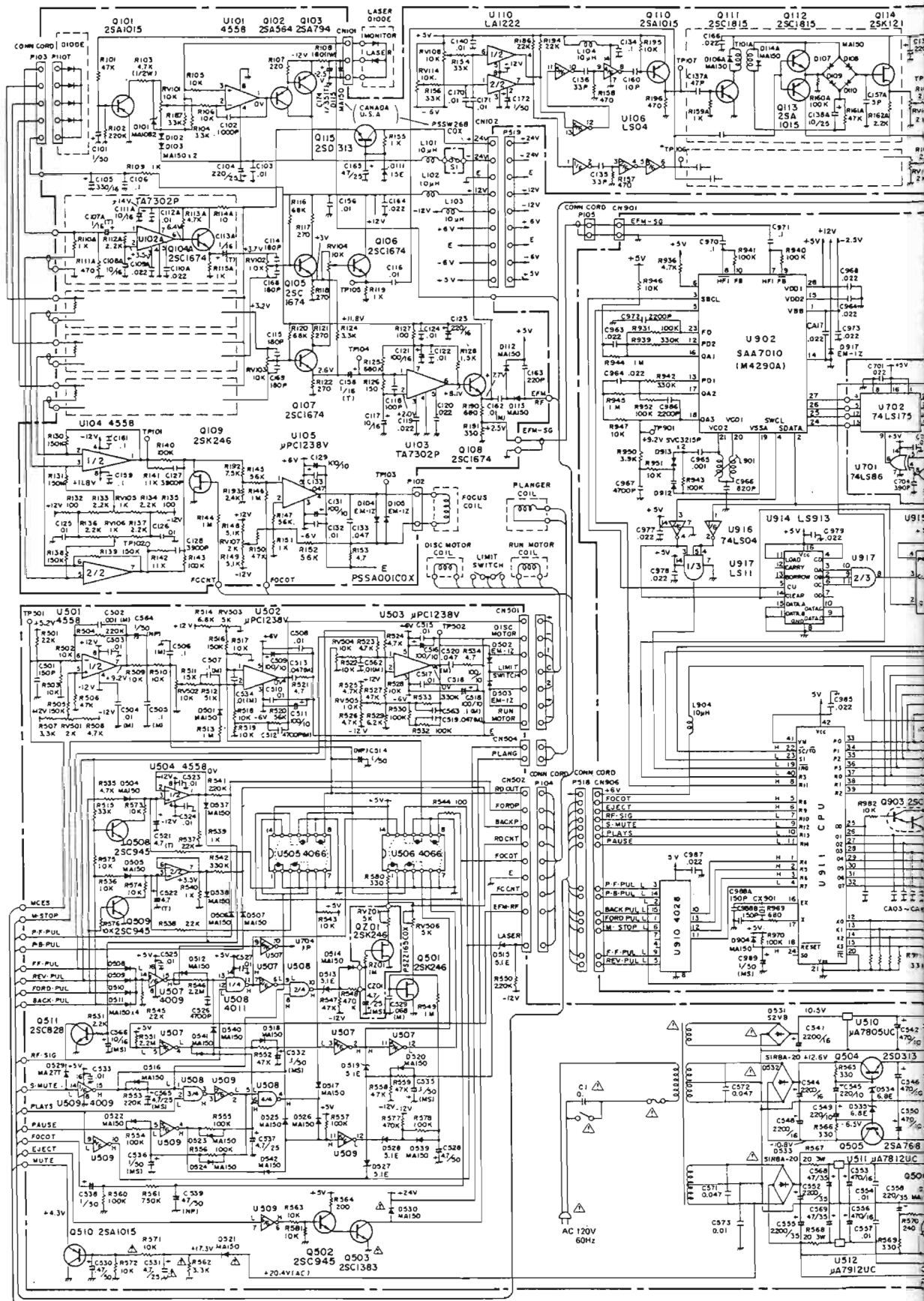

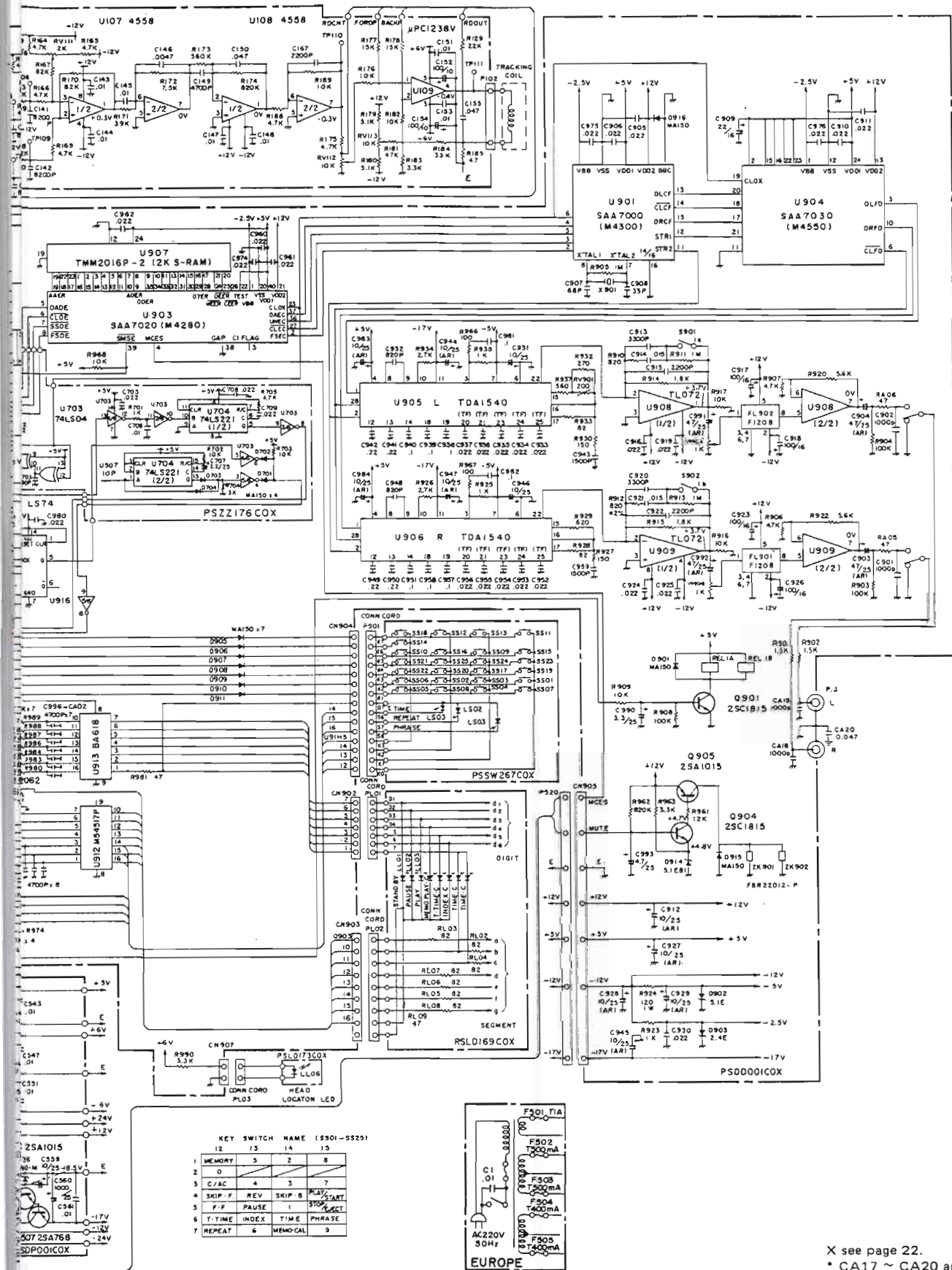

KEY SWITCH NAME (S301-SS20)

1	MEMORY	3	2	8
2	0	4	3	7
3	C/AC	5	1	6
4	SKIP-F	6	SKIP-B	5
5	F.F	7	PAUSE	4
6	T-TIME	8	INDEX	3
7	REPEAT	9	MEMO-CL	2

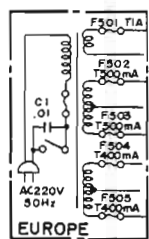

X see page 22.
 * CA17 ~ CA20 are used for EUROPE version

Exploded view

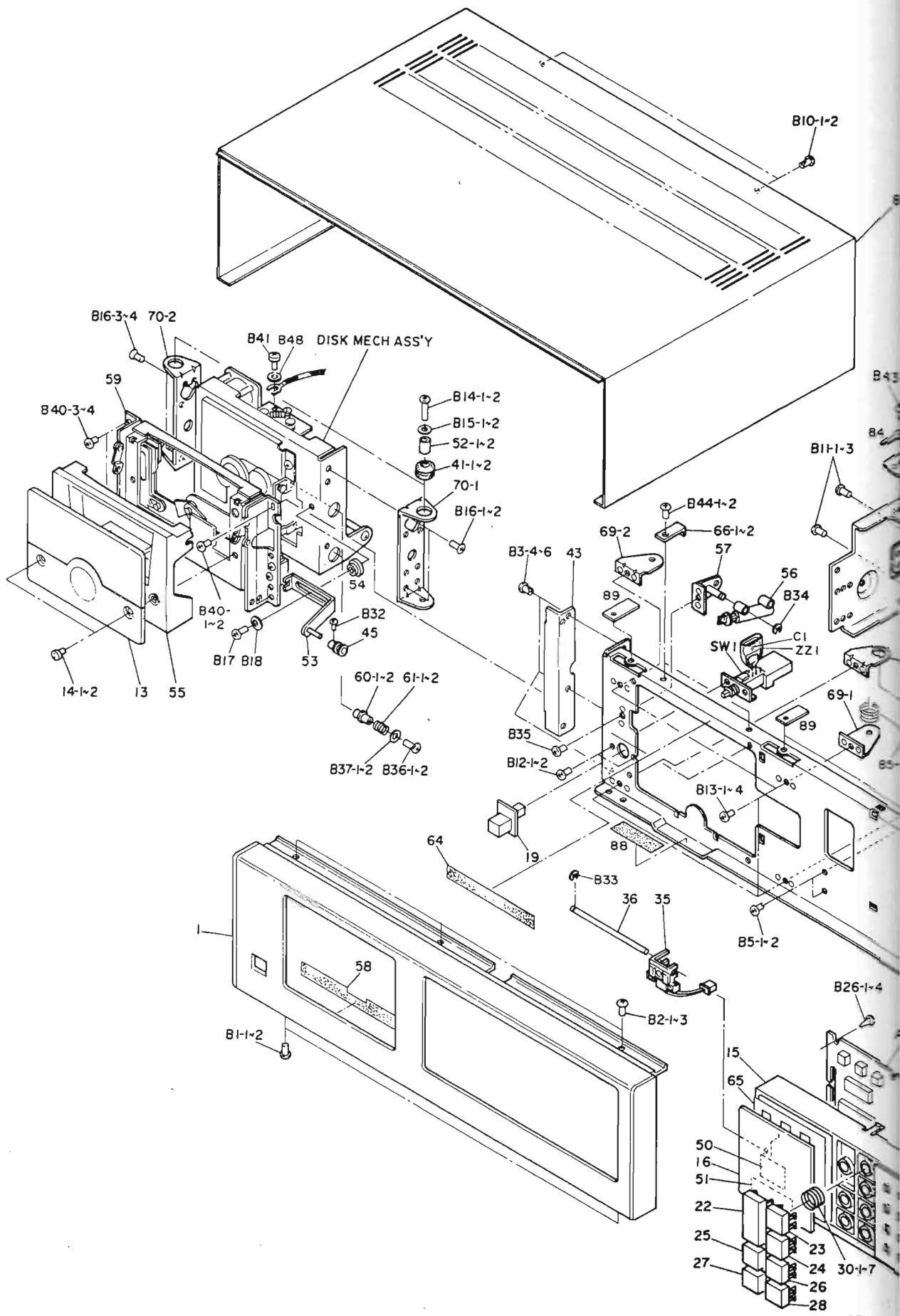

Replacement Parts List

① U.S.A. version
 ② EUROPE version

① Serial Nos. 304G1001~1100, 305G0451~1070, 305G1101~1441,
 ② Serial Nos. 307G1071~1670,
 ③ Serial No. 310G1671

Overall

Symbol No.	Description	Part No.
1	Escutcheon assembly	AM9500**01
(1-A)	Escutcheon	ME9EAM008)
(1-B)	Guide, button	VF132ST004)
(1-C)	Side piece L	VB722SM002)
(1-D)	Side piece R	VB722SM003)
(1-E)	END CAP	VS725CM001)
(1-F)	Support S/P	VL711SN001)
2	Front panel	MB972SX007
3	Support, chassis left	MB862SX007
4	Support, chassis right	MU852SX012
5	Bracket, power transformer	MB851SX001
6	Rear panel	MB972SE123
6	Rear panel	MB972SE133
7	Cover, bottom	MS986SX027
8	Cover, cabinet	MU897SM020
9	Support, PC board	ML332SX006
10	Support, PC board	ML321SL001
13	Compartment, disc	AM9500**02
14	Screw	MT163SM001
15	Frame	VE86JSM040
16	Escutcheon, indicator	VS668AK006
19	Push button POWER	VN330SP008
20	Button	VN210SM016
21	Button	VN230SM037
22	Button PLAY	VN250SM004
23	Button STOP/EJECT	VN230SM038
24	Button	VN230SM039
25	Button SKIP (reverse)	VN230SM040
26	Button SKIP (forward)	VN230SM041
27	Button REV	VN230SM042
28	Button FF	VN230SM043
29	Knob LEVEL	VN276SM052
30	Spring	MW371LY001
35	Holder LED	VX222SB001
36	Rod	MT632SB002
41	Absorber	VM277RB004
42	Pedestal	VM284RB005
43	Spacer, cover L	MU722SL003
44	Plate	MS317SZ006
45	Holder, guide	MT163BD015
50	Filter	VS425CS001
51	Filter, indicator	VS525CS001
	HEAD LOCATION	
52	Shaft, pulley	MT264BD011
53	Bracket assembly, LED	AVBRCKT013
(53-A)	Bracket LED	MU163SL001)
(53-B)	Pin, guide	MT232LD001)
54	Guide	MT155BD001
55	Cover	VB763SB009
56	Damper, air	ZZZ0000195
57	Damper, bracket	ML332SX007
58	Sheet	VS713YB001
59	Loading assembly, page 27	AVL0ADG001
60	Guide	MT164BD027
61	Spring	MW151LY007
62	Cover	MZ721SL001
63	Bracket, blind	MU722SE001
64	Sheet	VS615YB002

Symbol No.	Description	Part No.
65	Sheet, indicator	VS662XF003
66	Plate, locking	ML121SX003
67	Plate, locking	AVBRCKT014
68	Bracket	ML341SX002
69	Bracket	ML341SX003
70	Bracket	MU363SX003
71	Bracket, PC board	ML241SX005
72	Bracket, PC board	MX766SX001
73	Bracket, PC board	ML243SX002
75	Bracket, PC board	ML321SX002
81	Sheet	VS802RF001
83	Clamp	MX415SZ001
84	Clamp	MX615SZ001
85	Spring	MW371LY003
88	Sheet panel	VS566CB001
89	Spacer	MS316SX004
90	Support, PC board	ML322SX003
B1	Screw M3/8	*
B2	Screw M3/8	*
B3	Screw M3/8	*
B4	Screw M3/8	*
B5	Screw M3/8	*
86	Screw M3/8	*
B7	Screw M3/8	*
B8	Screw M3/8	*
B10	Screw M3/8	*
B11	Screw M3/6	*
B12	Screw M3/6	*
B13	Screw M3/6	*
B14	Screw M3/18	*
B15	Washer 3mm	*
B16	Screw M3/6	*
B17	Screw M3/8	*
B18	Washer 3mm	*
B19	Screw M3/6	*
B20	Screw M4/16	*
B21	Nut	*
B23	Rivet 3.5/5.5	*
B24	Screw M3/10	*
B26	Screw M2.6/6	*
B27	Screw M2.6/6	*
B28	Screw M3/8	*
B29	Screw M3/8	*
B30	Screw M3/8	*
B31	Screw M3/8	*
B32	Screw hex M2.6/4	*
B33	Ring E2	BCE2050XLD
B34	Ring E1.5	BCE1540XLD
B35	Screw M3/6	*
B36	Screw M3/10	*
B37	Washer 3mm	*
B38	Rivet 3/4.5	*
B39	Screw M3/8	*
B40	Screw M3/6	*
B41	Screw M2/4	*
B42	Screw M3/8	*
B43	Screw M3/8	*
B44	Screw M3/6	*

** = These parts are listed for reference only, Phase Linear will not supply these parts.

Symbol No.	Description	Part No.
B45	Screw M3/6	*
B46	Screw M3/8	*
B47	Washer 3mm	*
B48	Washer 2mm	*
B49	Washer 3mm	*
B50	Screw M3/8	*
B51	Screw M3/8	*
B52	Screw M3/8	*
B53	Screw M3/6	*

Symbol No.	Description	Part No.	
ACB1	Strain relief	*	①
ACB1	Strain relief	*	②
AC1	AC cord assembly	ACAC029ULA	③
AC1	AC cord assembly	ACAC035EEA	④
C1	Capacitor, polyester	CQEC472MEN	⑤
C1	Capacitor, polyester	CQHZ103MEN	⑥
SW1	Switch, POWER ESB-70702V	SP01AAW01N	⑦
SW1	Switch, POWER ESB-70702V	SP01AAW01N	⑧
T1	Transformer, power 117V UL-listed	TPG65U001P	⑨
T1	Transformer, power 220V SEMKO/VDE	TPG65S001P	⑩
ZZ1	Protective cover, C1	VX331VL001	
ZZ2	Connector	ZZZ0000154	⑪

"* = These parts are listed for reference only, Phase Linear will not supply these parts."

Player mechanism assembly: AJV0ML001S

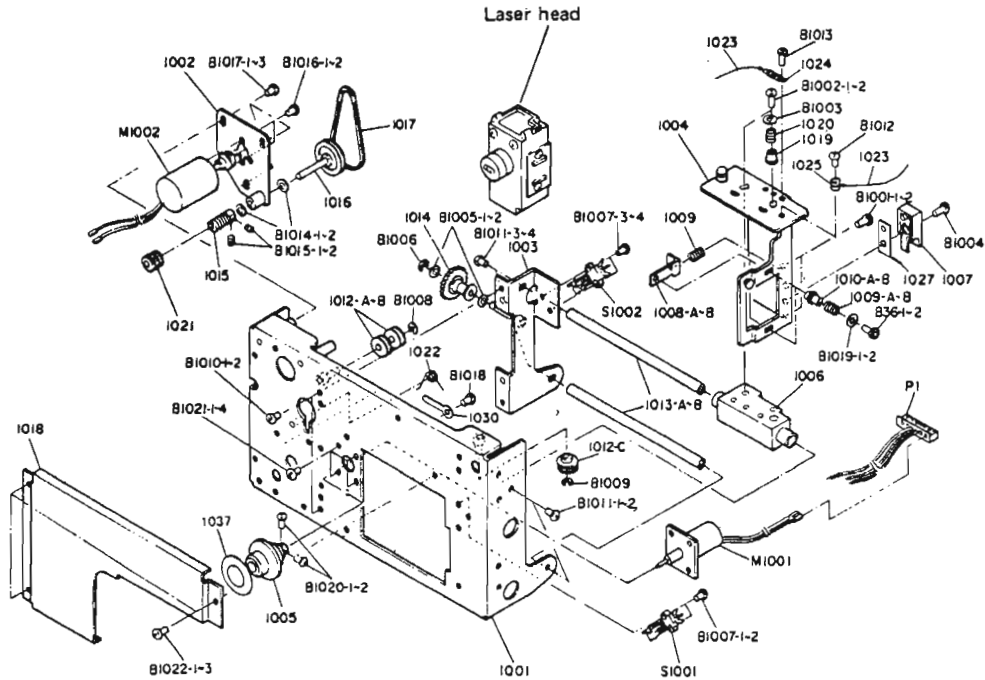

Symbol No.	Description	Part No.
S1001/1002	Switch, limit	SZ010202ZE
1001	Chassis assembly	AVCHASS001
1002	Chassis assembly MA	AVBRCKT010
1003	Bracket assembly guide	AVBRCKT011
1004	Bracket assembly PU	AVBRCKT012
1005	Table assembly	AVTABLE001
1006	Bearing A	VB632DX001
1007	Guide slide	VK221DN001
1008	Bracket, PU adjust	ML232SL006
1009	Spring, PU adjust	MW151LY006
1012	Pully S	MT162BD002
1013	Shaft, guide	MT763LY001
1014	Gear A	VM286DN001
1015	Gear B	MT263BD013
1016	Pulley assembly	AVPULLY004
1017	Belt	VM180RB009
1018	Trim plate	MC761SX001
1019	Bushing rad	MT164BD028
1020	Spring B	MW151LY007
1021	Gear, collar	MW160BD002
1022	Gear, spring	MW164LY001
1023	String	VWX01XX002
1024	Spring, string	MW151LY008
1025	Collar, string	MT150BD001
1027	Spring slide	MS312LY001
1030	Clamp	MX215SN002
1037	Sheet	VS802RF001

Symbol No.	Description	Part No.
B1005	Poly washer 2.1/4.0/0.25T	*
B1001	Screw M3/8	*
B1002	Screw M3/12	*
B1003	Washer 3mm	*
B1004	Screw M3/12	*
B1006	Ring E1.5/0.4	BCE1540XLD
B1007	Screw M2/8	*
B1008	Ring E1.5/0.4	*
B1010	Screw M3/5	*
B1011	Screw M3/8	*
B1012	Screw M3/8	*
B1013	Shaft pulley	MT142SN001
B1014	Poly wahser 2.6/4.7/0.25T	*
B1015	Screw M2/3	*
B1016	Screw M2/4	*
B1017	Screw M2.6/5	*
B1018	Screw M2.6/3	*
B1020	Screw M2.3/3	*
B1021	Screw M3/5	*
B1022	Screw 2.6/3	*
M1001	Motor CCL-1843A-01	ZNM0041501
M1002	Motor LS22-AA	ZNM0064501
	Laser head	HLPLO30010
P1	Cord assembly	ACCNB12GEA

"* = These parts are listed for reference only, Phase Linear will not supply these parts."

PC board assembly: APSSD001AD (U)
APSSD001BD (E)

Symbol No.	Description	Part No.
CA	Ceramic vibrator KBR-4.4M	CX4400001%
CA00-10	Capacitor, chip 4700p 50V	CFHD472KB%
C901/902	Capacitor, styroflex 1000p 125V	CQTC102JEB
C915	Capacitor, styroflex 2200p 100V	CQSC222JCF
C922	Capacitor, styroflex 2200p 100V	CQSC222JCF
C996-999	Capacitor chip, 4700p 50V	CFHD472KB%
CA17	Capacitor, ceramic 0.022 16V	CKV1223N2Y
D901	Diode MA150	QDSMA150XN
D902	Diode RD5.1EB1	QDZ5R1EB1A
D903	Diode RD2.4EC	QDZ2R4ECXA
D904-911	Diode MA150	QDSMA150XN
D912/913	Diode SVC321SP	QDCVC321CC
D914	Diode RD5.1EB1	QDZ5R1EB1A
D915/916	Diode MA150	QDSMAK50XN
D917	Diode EM1Z	QDSEM1ZXXD
D918	Diode RD5.1EB1	QDZ5R1EB1A
FL901/902	Filter, low-pass F120B	FERR20L01U
J901	Socket 2-pin	YJP02S015U
J902	Socket, IC	YSC420002U
L901	RFC, VCO 208301020	TR07QP001S
L902/903	AFC, read	LHHZV04ZZZ
L904	AFC	LF100KE03Y
Q901	Transistor 2SC1815	QTC1815XBT
Q902	Transistor 2SA1015	QTA1015XDT
Q903	Transistor 2SC2062	QTC2062XAX
Q904	Transistor 2SC1815	QTC1815XBT
Q905	Transistor 2SA1015	QTA1015XDT
Q906/907	Transistor 2SC1815	QTC1815XBT
RV901	VR, 200B	PR1NB20101
R910	Resistor, metal-oxide 820	RQBNJ8200X
R912	Resistor, metal-oxide 820	RQBNJ8200X
R914/915	Resistor, metal-oxide 1.8K	RQBNJ1801X
R924	Resistor, metal-oxide 120 1W	RG1ANJ121B
R928	Resistor, metal-oxide 82 2%	RQBNG0820X
R929	Resistor, metal-oxide 620	RQBNG6200X
R932	Resistor, metal-oxide 270 2%	RQBNG2700X
R933	Resistor, metal-oxide 82 2%	RQBNG0820X
R937	Resistor, metal-oxide 560 2%	RQBNG5600X
S901/902	Switch, reed FDR-4H	SZ010110Z6
U901	IC SAA7000	QQMA7000AZ
U902	IC SAA7010	QQMA7010AZ
U903	IC SAA7020	QQMA7020AZ
U904	IC SAA7030	QQMA7030AZ
U905/906	IC TDA1540	QQMA1540AZ
U907	IC TMM2016P	QQNM2016AT
U908/909	IC TL072CP	QQM00072BU
U910	IC TC4028BP	QQ004028AT
U911	IC MB88401	QQNC1001AF
U911	IC MB88401-P	QQNC1001BF
U912	IC M54517P	QQM54517PE
U913	IC BA618	QQMBA618AX
U914	IC M74LS193P	QQT74193AE
U915	IC SN74LS74AN	QQT07474AU
U916	IC SN74LS04N	QQT07404AU
U917	IC SN74LS11N	QQT07411AU
VR901	VR, 1 kB	RVQA102B02
X901	Crystal osc. 4.2336 MHz	XAZ1C3001X
ZK901/902	Relay FBR22	ZRA133107Z

PC board assembly: APSPD001AD (U)
APSPD001CD (E)

Symbol No.	Description	Part No.
C571/572	Capacitor, polyfilm 0.047 2000-DC	CQFD473MEN
D501	Diode MA150	QDSMA150XN
D502/503	Diode EM1Z	QDSEM1ZXXD
D504-512	Diode MA150	QDSMA150XN
D513	Diode RD5.1EB1	QDZ5R1EB1A
D514	Diode MA150	QDSMA150XN
D515	Diode RD5.1EB1	QDZ5R1EB1A
D516-518	Diode MA150	QDSMA150XN
D519	Diode RD5.1EB1	QDZ5R1EB1A
D520-526	Diode MA150	QDSMA150XN
D527/528	Diode RD5.1EB1	QDZ5R1EB1A
D529	Diode MA-27T-B	QDSMA27TBN
D530	Diode MA150	QDSMA150XN
D531	Diode S2VB	QDSS2VBXXK
D532/533	Diode S1RBA	QDSS1RBAXXK
D534/535	Diode RD6.8EB2	QDZ6R8EB2A
D536	Diode MA1180M	QDZA1180MN
D537-545	Diode MA150	QDSMA150XN
F501	Fuse	ZFBQ10201A
F502/503	Fuse	ZFBQ50104A
F504/505	Fuse	ZFBQ40102A
Q501	Transistor 2SK246	QTK0246XAT
Q502	Transistor 2SC945	QTC0945XBA
Q503	Transistor 2SC1383	QTC1383XCN
Q504	Transistor 2SD313	QTD0313XDC
Q505	Transistor 2SA768	QTA0768XBD
Q506	Transistor 2SA1015	QTA1015XDT
Q507	Transistor 2SA768	QTA0768XBD
Q508/509	Transistor 2SC945	QTC0945XBA
Q510	Transistor 2SA1015	QTA1015XDT
Q511	Transistor 2SC828	QTC0828XBN
RV501	VR 2 kB	RP1NB20201
RV502	VR 10 kB	RP1NB10301
RV503	VR 5 kB	RP1NB50201
RV504/505	VR 10 kB	RP1NB10301
RV506	VR 5 kB	RP1NB50201
R567/568	Resistor, metal-oxide 22 3W	RX3ARJ220B
U501	IC NJM4558D	QQM04558AJ
U502/503	IC UP1238V	QQM01238AA
U504	IC NJM4558D	QQM04558AJ
U505/506	IC TC4066BP	QQ004066BT
U507	IC HD14049UBP	QQ14049CB
U508	IC TC4011UBP	QQ004011DT
U509	IC HD14049UBP	QQ014049CB
U510	IC UA7805UC	QQM07805A4
U511	IC UA7812UC	QQM07812A4
U512	IC UA7912UC	QQM07912A4

PC board assembly: APSSA001BD (U)
APSSA001AD (E)

Symbol No.	Description	Part No.
D101	Diode MA1082M	QDZA1082MN
D102/103	Diode MA150	QDSMA150XN
D104/105	Diode EM1Z	QDSEM1ZXXD

* = These parts are listed for reference only, Phase Linear will not supply these parts."

Symbol No.	Description	Part No.
D106-110	Diode MA150	QDSMA150XN
D111	Diode RD15EB1	QDZ150EB1A
D112-114	Diode MA150	QDSMA150XN
L101-104	RFC	LF100KE03Y
Q101	Transistor 2SA1015	QTA1015XDT
Q102	Transistor 2SA564A	QTA0564ACN
Q103	Transistor 2SA794	QTA0794XAN
Q104-108	Transistor 2SC1674	QTC1674XBA
Q109	Transistor 2SK246	QTK0246XAT
Q110	Transistor 2SA1015	QTA1015XDT
Q111-112	Transistor 2SC1815	QTC1815XAT
Q113	Transistor 2SA1015	QTA1015XDT
Q114	Transistor 2SK121	QTK0121XAS
Q115	Transistor 2SD313	QTD0313XDC
RV101-104	VR 10 k Ω	RP1NB10301
RV105/106	VR 1 k Ω	RPJNB10210
RV107	VR 2 k Ω	RP1NB20201
RV108	VR 10 k Ω	RP1NB10301
RV109-111	VR 2 k Ω	RP1NB20201
RV112	VR 10 k Ω	RPJNB10310
RV113	VR 10 k Ω	RPFB10301
RV114	VR 10 k Ω	RP1NB10301
R103	Resistor, metal-oxide 4.7k 1/2W	RGHANJ472B
R108	Resistor, metal-oxide 180 1W	RG1ANJ181B
T101	Transformer, pulse	LWD2R8001S
U101	IC NJM4558D	QQM04558AJ
U102/103	IC TA7302P	QQM07302AT
U104	IC NJM4558D	QQM04558AJ
U105	IC UP1238V	QQM01238AA
U106	IC SN74LS04N	QQT07404AU
U107/108	IC NJM4558D	QQM04558AJ
U109	IC UP1238V	QQM01238AA
U110	IC LA1222	QQMA1222AC

PC board assembly: APSZZ166AA

Symbol No.	Description	Part No.
D301/302	Diode MA150	QDSMA150XN
Q301	Transistor 2SC945	QTC0945XBA
Q302	Transistor 2SK68	QTK0068XBA

PC board assembly: APSLD169BA

Symbol No.	Description	Part No.
DL01	Diode MA150	QDSMA150XN
LL01	LED LD-101UR red	QLALD101RX
LL02	LED LD-101DU	QLALD101UX
LL03	LED LD-101GG green	QLAD101GX
LL04	LED GL-7H202	QL-L7H2023
LL05	LED LC-204MB green	QL#LC204MX

PC board assembly: APSLD173AA

Symbol No.	Description	Part No.
LL06	LED AR2222S	QLAAR2222R

PC board assembly: APSSW267AA

Symbol No.	Description	Part No.
LEDS01-03	LED TLR205 red	QLATLR205T
QS01-03	Transistor 2SA1015	QTA1015XCT
SS01-18	Switch, key KHC10906	SK0101X11A
SS19-25	Switch, key KHC10902	SK0101X05A

PC board assembly: APSSW267BA

Symbol No.	Description	Part No.
LEDS01-03	LED TLR205 red	QLATLR205T
SS01-25	Switch, key KHC10902	SK0101X05A

PC board assembly: APSZZ165AA

Symbol No.	Description	Part No.
QZ01	Transistor 2SK246	QTK0246XAT
RVZ01	VR 5 k Ω	RP1NB50201

PC board assembly: APSZZ176AA

Symbol No.	Description	Part No.
D701-704	Diode MA150	QDSMA150XN
U701	IC SN74LS86N	QQT07486AU
U702	IC M74LS175P	QQT74175AE
U703	IC SN74LS04N	QQT07404AU
U704	IC SN74LS221N	QQT74221AU

PC board assembly: APSZZ176CA (U)
APSZZ176DA (E)

Symbol No.	Description	Part No.
D701-704	Diode MA150	QDSMA150XN
L701	Choke coil	LF100KE03Y
U703	IC SN74LS04N	QQT07404AU
U704	IC SN74LS221N	QQT74221AU

PC board assembly: APSSW268AA (U)

Symbol No.	Description	Part No.
S1	Switch, micro SS-5GL-13	SM010215ZR

Accessories	Part No.
Manual, operation original	*
Carton	*
Partitioner	*
Partitioner	*
Audio cable set	ACPP007ULA

* = These parts are listed for reference only, Phase Linear will not supply these parts."